

Chains & sprockets	Wear strips	Side guide brackets & accessories	Levelers
Modular belts & sprockets	Chain & belt return systems	Frame & structure supports	Bearing supports
Curves & tracks	Side guide solutions	Miscellaneous products	Related information

1 0 1 1 0 a

GENERAL INDEX

www.SystemPlastSmartGuide.com

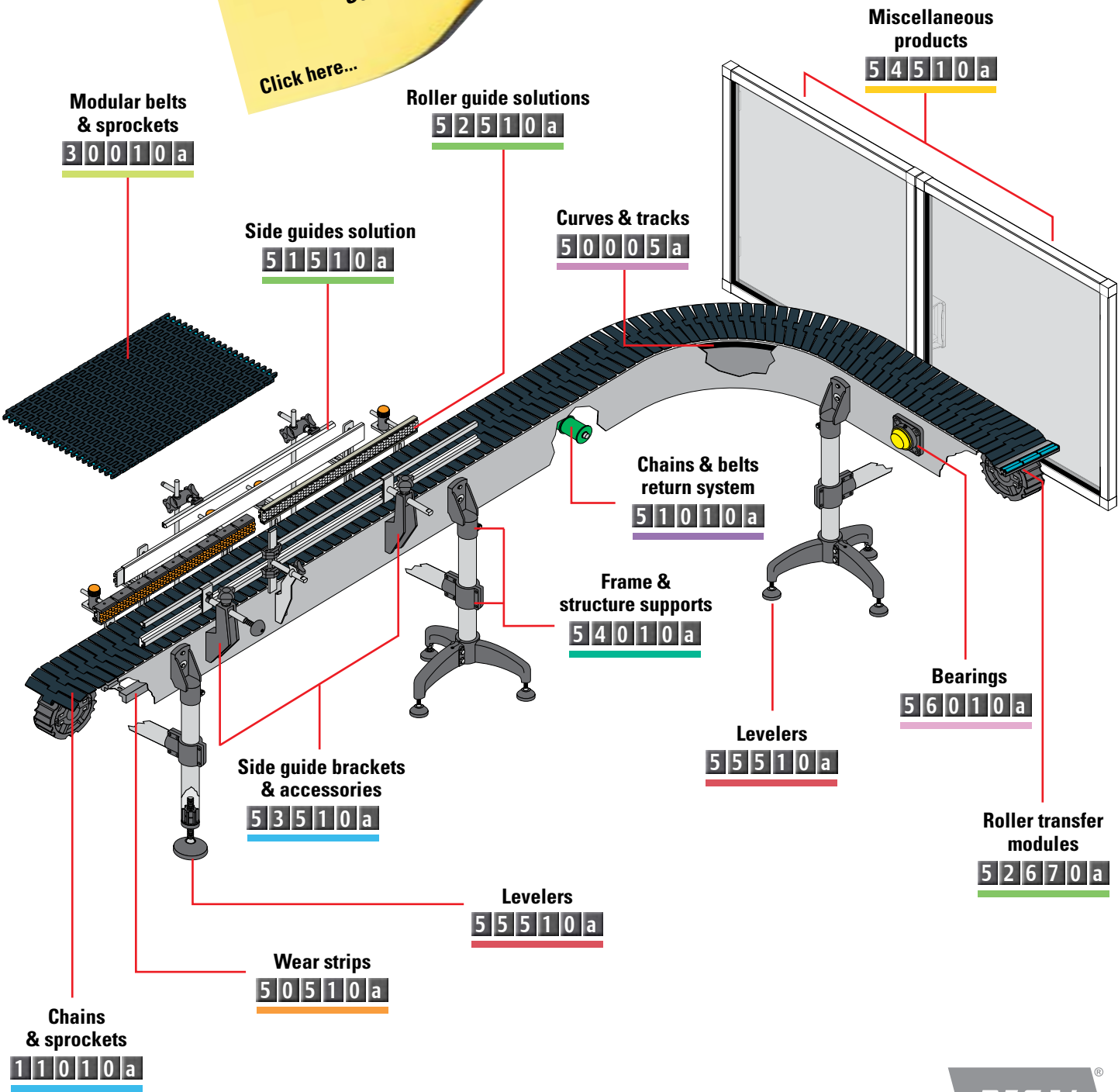
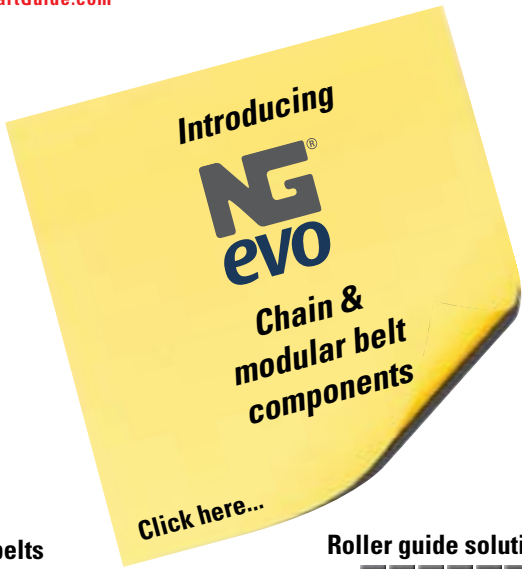

Chains & sprockets	Wear strips	Side guide brackets & accessories	Levelers
Modular belts & sprockets	Chain & belt return systems	Frame & structure supports	Bearing supports
Curves & tracks	Side guide solutions	Miscellaneous products	Related information

INTRODUCTION

Smart Guide visual index.....	10110a
Smart Guide catalog index.....	10110b
How Smart Guide works.....	10110c
Smart Guide icon legend.....	10110d

CHAINS & SPROCKETS

Index metal chains & sprockets.....	11010a
Index straight thermoplastic chains & sprockets.....	11011a
Index sideflexing thermoplastic chains & sprockets.....	11012a
Index other types sideflexing chains & sprockets.....	11013a

MODULAR BELTS & SPROCKETS

Index straight modular belts & sprockets.....	30010a
Index sideflexing modular belts & sprockets.....	30012a
Index ½" pitch (12,7mm) - Thickness: 8,7mm.....	30020a
Index ¾" pitch (19mm) - Thickness: 8,7mm.....	30190a
Index 1" pitch (25,4mm) - Thickness: 8,7mm.....	30300a
Index 1" pitch (25,4mm) - Thickness: 12,7mm.....	30410a
Index 1" pitch (25,4mm).....	30700a
Index sideflexing modular belts 2256.....	30728a

CURVES & TRACKS

Introduction to curves.....	50005a
Index magnetic curves.....	50010a

WEAR STRIPS

Index wear strips.....	50510a
------------------------	---------------

CHAIN & BELT RETURN SYSTEMS

Index chain & belt return systems.....	51010a
--	---------------

SIDE GUIDE SOLUTIONS

Index side guides & clamps.....	51510a
Index roller side guides & roller transfer plates.....	52510a

SIDE GUIDE BRACKETS & ACCESSORIES

Index side guides brackets.....	53510a
---------------------------------	---------------

FRAME & STRUCTURE SUPPORTS

Index frame & structure supports.....	54010a
---------------------------------------	---------------

MISCELLANEOUS PRODUCTS

Index miscellaneous products.....	54510a
-----------------------------------	---------------

LEVELERS

Index levelers & tube ends.....	55510a
---------------------------------	---------------

BEARINGS

Index mounted bearings.....	56010a
-----------------------------	---------------

RELATED INFORMATION

Index related information.....	70050a
--------------------------------	---------------

ITEM DESCRIPTION INDEX

Item description index.....	78000a
-----------------------------	---------------

STANDARD TERMS AND CONDITIONS OF SALE

Standard terms and conditions of sale.....	79900a
--	---------------



Chains & sprockets	Wear strips	Side guide brackets & accessories	Levelers
Modular belts & sprockets	Chain & belt return systems	Frame & structure supports	Bearing supports
Curves & tracks	Side guide solutions	Miscellaneous products	Related information

10110c

HOW SMART GUIDE® CATALOG WORKS

www.SystemPlastSmartGuide.com

The page codes of this catalog opens your access to all relevant information and services about the product you have selected on www.SystemPlastSmartGuide.com



Click here for related information.

- Related information:
- Design guidelines
 - General information
 - Construction details
 - Calculations

Clicking on product code directly available:

- Download DWG and STP files
- Possibility to create your bill of material for enquiry or purchase



SPEC®
Load and strength calculator



Our interactive catalog is your key to direct access to the System Plast® SmartGuide® website, where you will find all possible information and tools to assist you in selecting, applying our products

Chains & sprockets	Wear strips	Side guide brackets & accessories	Levelers
Modular belts & sprockets	Chain & belt return systems	Frame & structure supports	Bearing supports
Curves & tracks	Side guide solutions	Miscellaneous products	Related information

1 0 1 1 0 d

LEGEND ICONS

www.SystemPlastSmartGuide.com

ICON	LEGEND
	Link to open menu for technical information related to the products listed on this page. <small>Click here for related information.</small>
	Link to find related products.
	Link to find related products. Note: only available on our website www.SystemPlastSmartGuide.com
	Codes in orange background are indicators for modular belts in molded to width versions.
	Information only available on our website: www.SystemPlastSmartGuide.com
	Link to other varieties of these chains and/or link to the chains used with the sprockets listed on this page.
	Link to other varieties of these modular belts and/or link to the belts used with the sprockets listed on this page.
	Link to the sprockets used with the chains or belts listed on this page.
	Minimum order quantity.
	Indicates chains, belts or curves suitable for magnetic curve systems.
	This product includes patented features.
	Link to general information about the products listed on this page.
	This product is not suitable in use with chains with hold-down tabs.











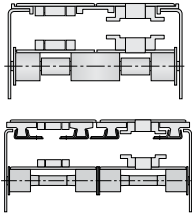

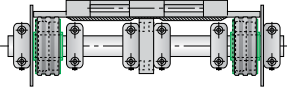
ICON	LEGEND
	Weight in Kg/m
	Length per standard code.
	Length per standard coil.
	Quantity standard packaging.
	Indication for products that contain a dry lubricant.
	Material: stainless steel AISI 430.
	Material: stainless steel AISI 304.
	Material: aluminum, anodized.
	Material: aluminum.
	Material: zinc plated steel.
	Nominal diameter 41mm.
	Product suitable for assembly to a rectangular profile.
	Max load capacity.
	Wrench size.

Chains & sprockets	Wear strips	Side guide brackets & accessories	Levelers
Modular belts & sprockets	Chain & belt return systems	Frame & structure supports	Bearing supports
Curves & tracks	Side guide solutions	Miscellaneous products	Related information

5 1 0 1 0 a

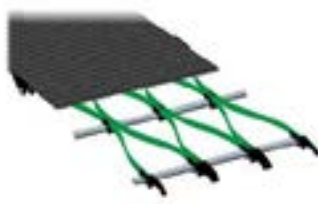
INDEX CHAIN & BELT ROLLERS SYSTEMS

www.SystemPlastSmartGuide.com

		Chain return rollers 85 mm center distance	5 1 0 2 0 a BLACK COLOR  5 1 0 6 0 a GREEN COLOR
		Chain return rollers Other center distances	5 1 0 3 0 a
		Watertight return rollers 27mm versions	5 1 0 4 0 a
		Watertight return rollers 40/43mm versions	5 1 0 5 0 a
		Watertight return rollers 82/85mm versions	5 1 0 8 0 a STANDARD  5 1 1 1 0 a SOLID VERSION
		Flanges for Return Rollers	5 1 0 9 0 a
		Wear strip & Clamps for serpentine system	5 1 1 2 0 a
		Little striker & Striker for serpentine system	5 1 1 3 0 a
		Sliding shoe & expansion plug for serpentine system	5 1 1 4 0 a
		Single spacer & Shoe wear strip for serpentine system	5 1 1 5 0 a
		Washer & Sliding shoe for serpentine system	 5 1 1 6 0 a
		Wearshoes for return system	5 1 1 7 0 a

 Information about this product is only available on our Smart Guide® website.

Chains & sprockets	Wear strips	Side guide brackets & accessories	Levelers
Modular belts & sprockets	Chain & belt return systems	Frame & structure supports	Bearing supports
Curves & tracks	Side guide solutions	Miscellaneous products	Related information

51020a

CHAIN RETURN ROLLERS

www.SystemPlastSmartGuide.com

 Click here for related information.

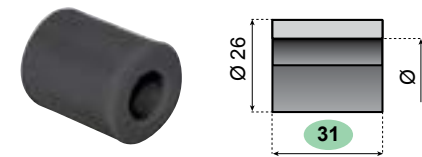
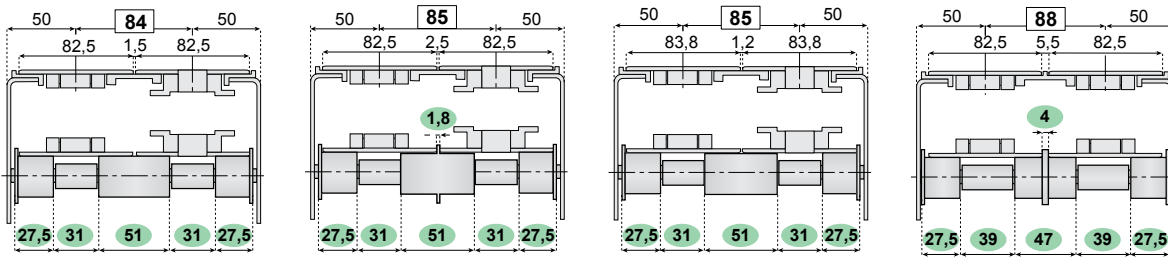

SPACER (LENGTH 31 mm)

MATERIAL	FOR ROD				
	Ø 12	Ø 16	Ø 18	Ø 20	
PA BLACK	R-26B12ML31-PAB	R-26B16ML31-PAB	R-26B18ML31-PAB	R-26B20ML31-PAB	100

External diameter  26

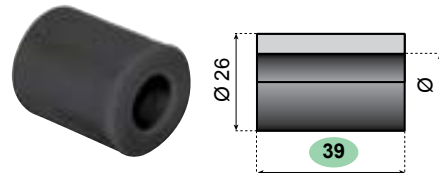

SPACER (LENGTH 39 mm)

MATERIAL	FOR ROD				
	Ø 12	Ø 16	Ø 18	Ø 20	
PA BLACK	R-26B12ML39-PAB	R-26B16ML39-PAB	R-26B18ML39-PAB	R-26B20ML39-PAB	100

External diameter  26

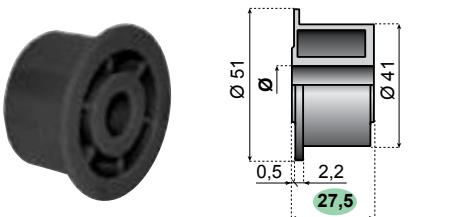

RETURN ROLLER WITH FLANGE

MATERIAL	FOR ROD				
	Ø 12	Ø 16	Ø 18	Ø 20	
PE-HD BLACK	RF-41B12ML28-PEB	RF-41B16ML28-PEB	RF-41B18ML28-PEB	RF-41B20ML28-PEB	100

External diameter  41

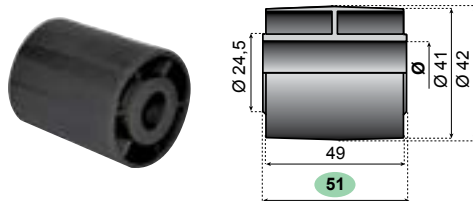

RETURN ROLLER

MATERIAL	FOR ROD				
	Ø 12	Ø 16	Ø 18	Ø 20	
PE-HD BLACK	R-41B12ML51-PEB	R-41B16ML51-PEB	R-41B18ML51-PEB	R-41B20ML51-PEB	100

External diameter  42

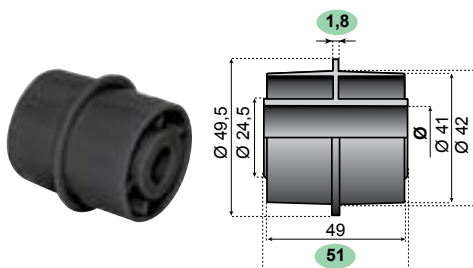

RETURN ROLLER WITH CENTER FLANGE

MATERIAL	FOR ROD				
	Ø 12	Ø 16	Ø 18	Ø 20	
PE-HD BLACK	RF-41B12ML51-PEB	RF-41B16ML51-PEB	RF-41B18ML51-PEB	RF-41B20ML51-PEB	100

External diameter  42

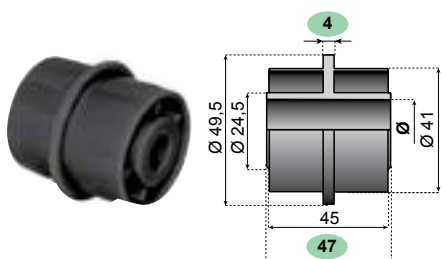

RETURN ROLLER WITH CENTER FLANGE

MATERIAL	FOR ROD				
	Ø 12	Ø 16	Ø 18	Ø 20	
PE-HD BLACK	RF-41B12ML47-PEB	RF-41B16ML47-PEB	RF-41B18ML47-PEB	RF-41B20ML47-PEB	100

External diameter  41

Also available in green color. Go to: [51060a](http://www.SystemPlastSmartGuide.com)

 Information about this product is only available on our Smart Guide® website.

Chains & sprockets	Wear strips	Side guide brackets & accessories	Levelers
Modular belts & sprockets	Chain & belt return systems	Frame & structure supports	Bearing supports
Curves & tracks	Side guide solutions	Miscellaneous products	Related information

5 1 0 3 0 a

CHAIN RETURN ROLLERS

www.SystemPlastSmartGuide.com



Click here for related information.

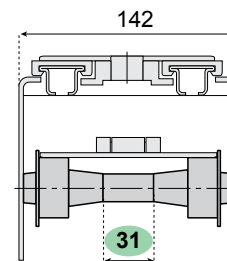
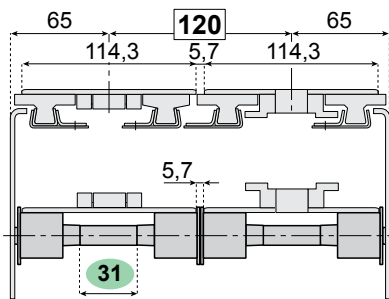
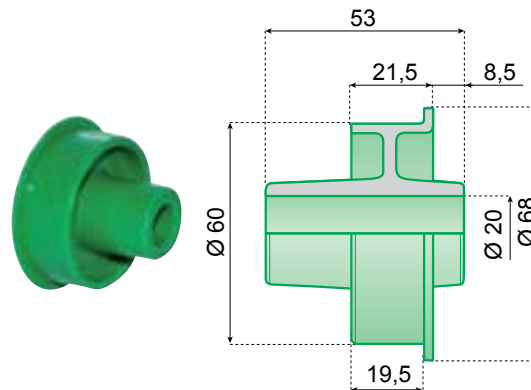
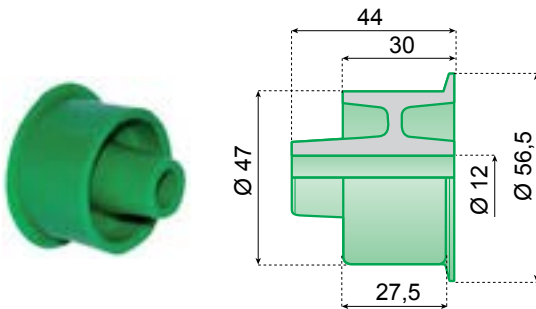

Go to: **5 1 0 2 0 a**

Go to: **5 1 0 2 0 a**

RETURN ROLLER WITH FLANGE

Ø 47 External diameter	SHAFT Ø12	
MATERIAL	ITEM DESCRIPTION	
PE-HD GREEN	RF-47B12ML44-PEG	
		100

RETURN ROLLER WITH FLANGE

Ø 60 External diameter	FOR ROD Ø 20	
MATERIAL	ITEM DESCRIPTION	
PE-HD GREEN	RF-60B20ML53-PEG	
		100

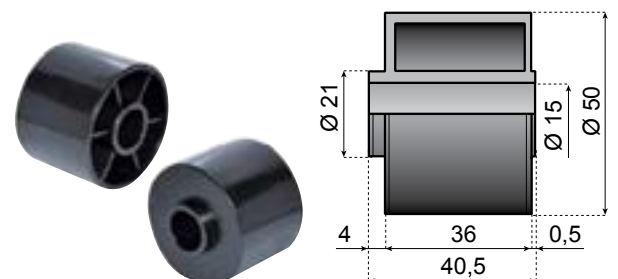
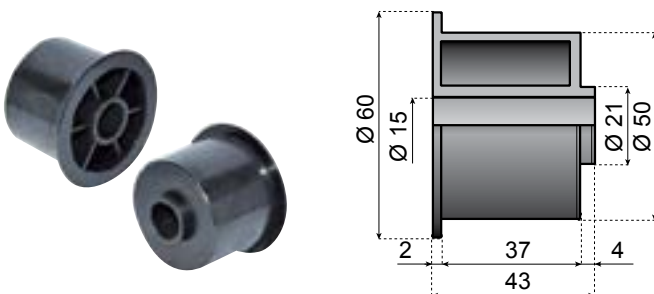

RETURN ROLLER WITH FLANGE

Ø 50 External diameter	FOR ROD Ø 15	
MATERIAL	ITEM DESCRIPTION	
PE-HD BLACK	RF-50B15ML43-PEB	
		100

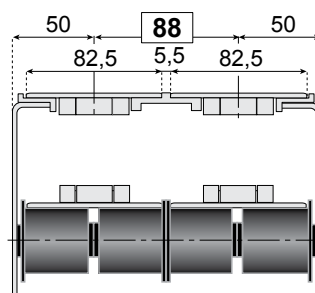

RETURN ROLLER

Ø 50 External diameter	FOR ROD Ø 15	
MATERIAL	ITEM DESCRIPTION	
PE-HD BLACK	RF-50B15ML41-PEB	
		100

Chains & sprockets	Wear strips	Side guide brackets & accessories	Levelers
Modular belts & sprockets	Chain & belt return systems	Frame & structure supports	Bearing supports
Curves & tracks	Side guide solutions	Miscellaneous products	Related information

5 1 0 4 0 a

ROLLERS FOR RETURN OF CHAINS & BELTS

www.SystemPlastSmartGuide.com

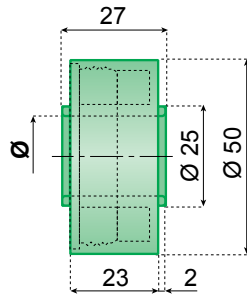

CHARACTERISTICS:

- Very low friction coefficient.
- No liquid absorption.
- Excellent wear and chemical resistance.
- Completely closed structure, easier to clean and disinfect.
- Watertight.



Click here for related information.



External diameter

WATERTIGHT ROLLER

MATERIAL	FOR ROD			ITEM DESCRIPTION	100
	Ø 16	Ø 18	Ø 20		
PE-HD GREEN	R-50B16ML27-PEG	R-50B18ML27-PEG	R-50B20ML27-PEG		
VERSION WITH FLANGE					
PE-HD GREEN	RF-50B16ML28-PEG	RF-50B18ML28-PEG	RF-50B20ML28-PEG		100

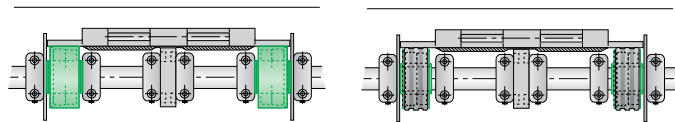

VERSION WITH FLANGE

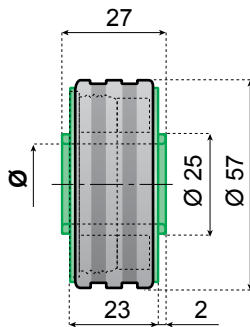
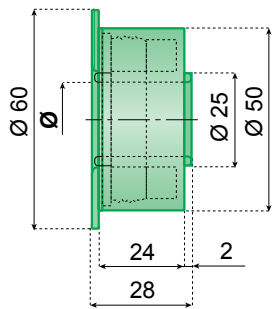

WATERTIGHT ROLLER WITH RUBBER

MATERIAL	FOR ROD			ITEM DESCRIPTION	100
	Ø 16	Ø 18	Ø 20		
PE-HD GREEN	RR-57B16ML27-PEG	RR-57B18ML27-PEG	RR-57B20ML27-PEG		
VERSION WITH FLANGE					
PE-HD GREEN	RRF-57B16ML28-PRG	RRF-57B18ML28-PRG	RRF-57B20ML28-PRG		100



External diameter

RUBBER MATERIAL: TPR

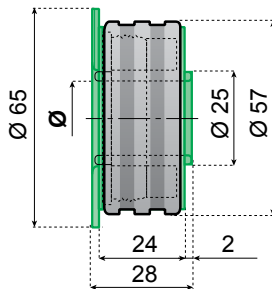

VERSION WITH FLANGE

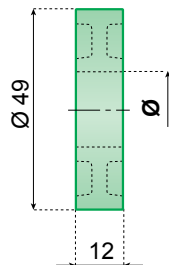

ROLLER

MATERIAL	FOR ROD			ITEM DESCRIPTION	100
	Ø 16	Ø 18	Ø 20		
PP GREEN	R-49B16ML12-PPG	R-49B18ML12-PPG	R-49B20ML12-PPG		

Chains & sprockets	Wear strips	Side guide brackets & accessories	Levelers
Modular belts & sprockets	Chain & belt return systems	Frame & structure supports	Bearing supports
Curves & tracks	Side guide solutions	Miscellaneous products	Related information

5 1 0 5 0 a

ROLLERS FOR RETURN OF CHAINS & BELTS

www.SystemPlastSmartGuide.com

CHARACTERISTICS:

- Very low friction coefficient.
- No liquid absorption.
- Excellent wear and chemical resistance.
- Completely closed structure, easier to clean and disinfect.
- Watertight.



Click here for related information.

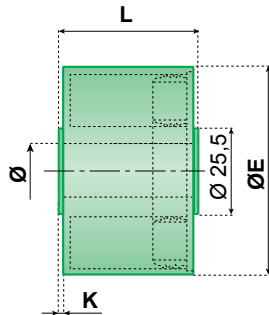

VERSION WITH FLANGE

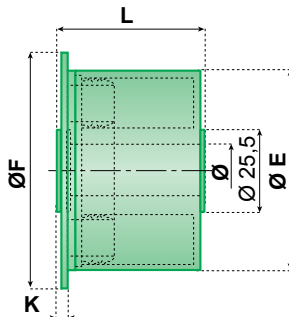

Ø 50 Ø 60 External diameter

WATERTIGHT ROLLER

MATERIAL	ØE	ØF	L	K	FOR ROD			ITEM DESCRIPTION	100
					Ø 16	Ø 18	Ø 20		
					PE-HD GREEN	50	-		
43	4	R-50B16ML43-PEG	R-50B18ML43-PEG	R-50B20ML43-PEG					
60	-	40,5	1,5	R-60B16ML41-PEG		R-60B18ML41-PEG	R-60B20ML41-PEG		
VERSION WITH FLANGE									
PE-HD GREEN	50	65	43	4	RF-50B16ML43-PEG	RF-50B18ML43-PEG	RF-50B20ML43-PEG	100	
	60	75			RF-60B16ML43-PEG	RF-60B18ML43-PEG	RF-60B20ML43-PEG		

Rollers with Diam. 60mm also available in black color. Min. order quantity: 300 pcs.

CHARACTERISTICS:

- Reduced noise level with rubber
- Very low friction coefficient.
- No liquid absorption.
- Excellent wear and chemical resistance.
- Completely closed structure, easier to clean and disinfect.
- Watertight.

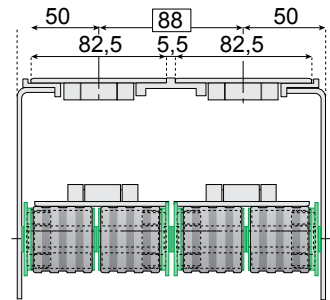
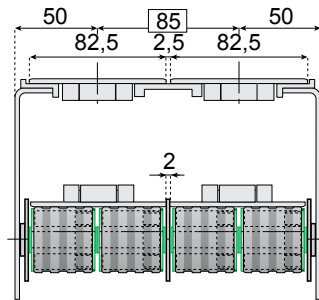
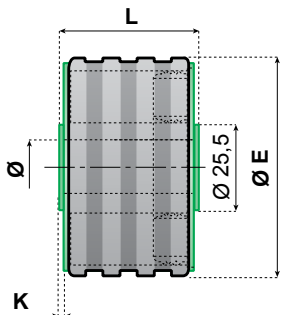

Ø 57 Ø 67 External diameter

WATERTIGHT ROLLER WITH RUBBER

MATERIAL	ØE	ØF	L	K	FOR ROD			ITEM DESCRIPTION	100
					Ø 16	Ø 18	Ø 20		
					PE-HD GREEN	57	-		
43	4	RR-57B16ML43-PEG	RR-57B18ML43-PEG	RR-57B20ML43-PEG					
67	-	40,5	1,5	RR-67B16ML41-PEG		RR-67B18ML41-PEG	RR-67B20ML41-PEG		
VERSION WITH FLANGE									
PE-HD GREEN	57	65	43	4	RRF-57B16ML43-PEG	RRF-57B18ML43-PEG	RRF-57B20ML43-PEG	100	

RUBBER MATERIAL: TPR

Rollers with Diam. 67mm also available in black color. Min. order quantity: 300 pcs.

VERSION WITH FLANGE

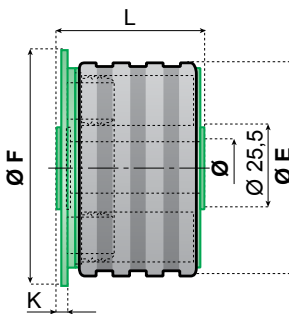

Chains & sprockets	Wear strips	Side guide brackets & accessories	Levelers
Modular belts & sprockets	Chain & belt return systems	Frame & structure supports	Bearing supports
Curves & tracks	Side guide solutions	Miscellaneous products	Related information

51060a
www.SystemPlastSmartGuide.com

CHAIN RETURN ROLLERS

Click here for related information.

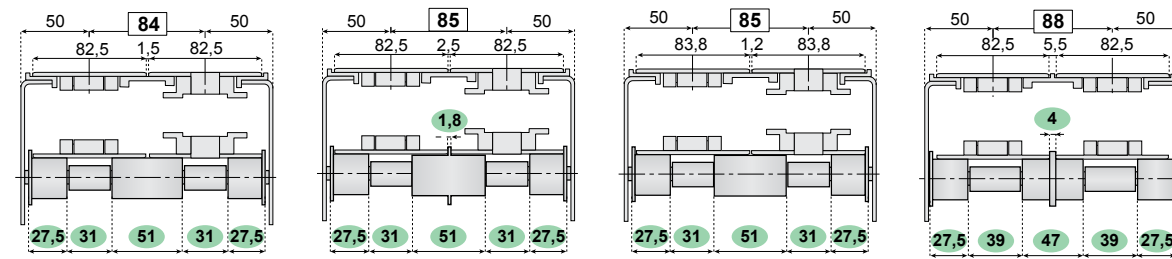

SPACER (LENGTH 31 mm)

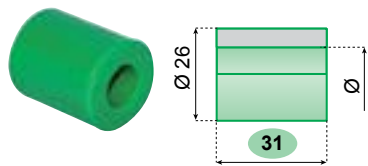

MATERIAL	FOR ROD				
	Ø 12	Ø 16	Ø 18	Ø 20	
ITEM DESCRIPTION					
PA GREEN	R-26B12ML31-PAG	R-26B16ML31-PAG	R-26B18ML31-PAG	R-26B20ML31-PAG	100

External diameter 26

SPACER (LENGTH 39 mm)

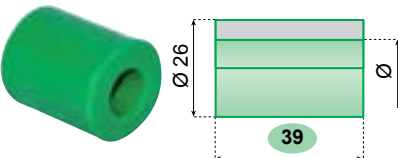

MATERIAL	FOR ROD				
	Ø 12	Ø 16	Ø 18	Ø 20	
ITEM DESCRIPTION					
PA GREEN	R-26B12ML39-PAG	R-26B16ML39-PAG	R-26B18ML39-PAG	R-26B20ML39-PAG	100

External diameter 26

RETURN ROLLER WITH FLANGE

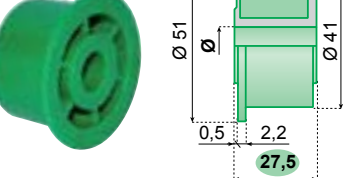

MATERIAL	FOR ROD				
	Ø 12	Ø 16	Ø 18	Ø 20	
ITEM DESCRIPTION					
PE-HD GREEN	RF-41B12ML28-PEG	RF-41B16ML28-PEG	RF-41B18ML28-PEG	RF-41B20ML28-PEG	100

External diameter 41

RETURN ROLLER

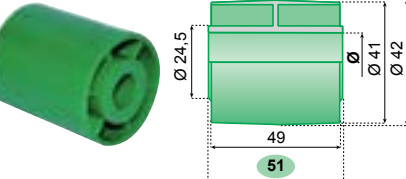

MATERIAL	FOR ROD				
	Ø 12	Ø 16	Ø 18	Ø 20	
ITEM DESCRIPTION					
PE-HD GREEN	R-41B12ML51-PEG	R-41B16ML51-PEG	R-41B18ML51-PEG	R-41B20ML51-PEG	100

External diameter 42

RETURN ROLLER WITH CENTER FLANGE

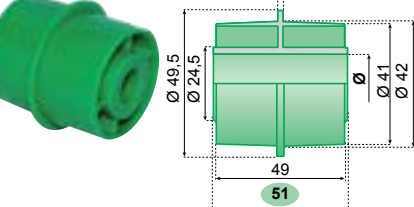

MATERIAL	FOR ROD				
	Ø 12	Ø 16	Ø 18	Ø 20	
ITEM DESCRIPTION					
PE-HD GREEN	RF-41B12ML51-PEG	RF-41B16ML51-PEG	RF-41B18ML51-PEG	RF-41B20ML51-PEG	100

External diameter 42

RETURN ROLLER WITH CENTER FLANGE

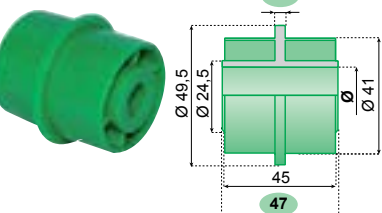

MATERIAL	FOR ROD				
	Ø 12	Ø 16	Ø 18	Ø 20	
ITEM DESCRIPTION					
PE-HD GREEN	RF-41B12ML47-PEG	RF-41B16ML47-PEG	RF-41B18ML47-PEG	RF-41B20ML47-PEG	100

External diameter 41

MOQ Min. order quantity: 500 pcs.

Information about this product is only available on our Smart Guide® website.

Also available in black color.
Go to: **51020a**

Chains & sprockets	Wear strips	Side guide brackets & accessories	Levelers
Modular belts & sprockets	Chain & belt return systems	Frame & structure supports	Bearing supports
Curves & tracks	Side guide solutions	Miscellaneous products	Related information

51080a

RETURN ROLLERS POLYETHYLENE

www.SystemPlastSmartGuide.com

CHARACTERISTICS:

- Very low friction coefficient
- No liquid absorption
- Excellent wear and chemical resistance
- Completely closed structure, easier to clean and disinfect
- Watertight

Also available with improved chemical resistance, go to:

51110a



Click here for related information.



Information about this product is only available on our Smart Guide® website.

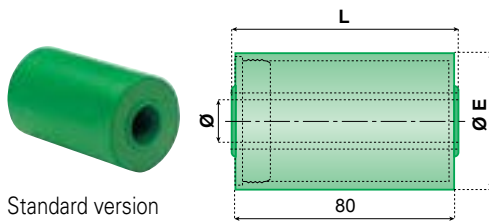

Standard version

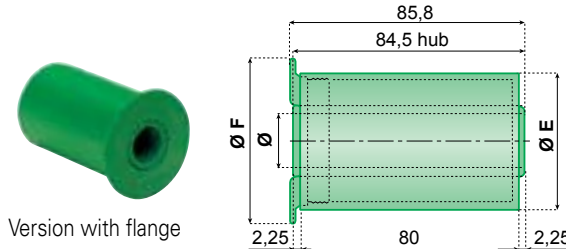

Version with flange

WATERTIGHT ROLLER

MATERIAL	Ø E	L	F	FOR ROD					ITEM DESCRIPTION
				Ø 12	Ø 14	Ø 16	Ø 18	Ø 20	
STANDARD VERSION									
PE-HD GREEN	40	82,5	-	-	-	R-40B16ML83-PEG	R-40B18ML83-PEG	R-40B20ML83-PEG	50
		84,5	-	-	-	R-40B16ML85-PEG	R-40B18ML85-PEG	R-40B20ML85-PEG	
	50	82,5	-	-	-	R-50B16ML83-PEG	R-50B18ML83-PEG	R-50B20ML83-PEG	
		84,5	-	-	-	R-50B16ML85-PEG	R-50B18ML85-PEG	R-50B20ML85-PEG	
	60	82,5	-	-	-	R-60B16ML83-PEG	R-60B18ML83-PEG	R-60B20ML83-PEG	
		84,5	-	R-60B12ML85-PEG	R-60B14ML85-PEG	R-60B16ML85-PEG	R-60B18ML85-PEG	R-60B20ML85-PEG	
VERSION WITH FLANGE									
PE-HD GREEN	40	85,8	55	-	-	RF-40B16ML86-PEG	RF-40B18ML86-PEG	RF-40B20ML86-PEG	50
	50	85,8	65	-	-	RF-50B16ML86-PEG	RF-50B18ML86-PEG	RF-50B20ML86-PEG	
	60	85,8	65	RF-60B12ML86-PEG	RF-60B14ML86-PEG	RF-60B16ML86-PEG	RF-60B18ML86-PEG	RF-60B20ML86-PEG	



External diameter

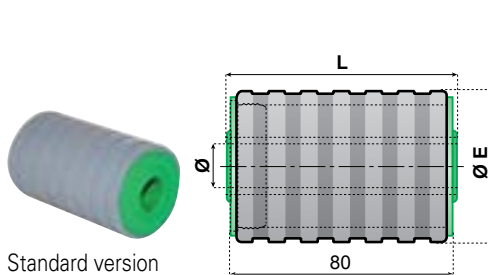

Standard version

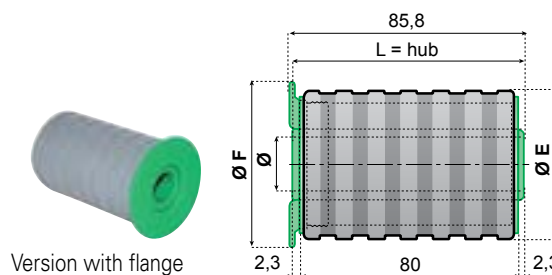

Version with flange

WATERTIGHT ROLLER WITH RUBBER

MATERIAL	Ø E	L	F	FOR ROD			ITEM DESCRIPTION
				Ø 16	Ø 18	Ø 20	
STANDARD VERSION							
PE-HD GREEN	47	82,5	-	RR-47B16ML83-PEG	RR-47B18ML83-PEG	RR-47B20ML83-PEG	50
		84,5	-	RR-47B16ML85-PEG	RR-47B18ML85-PEG	RR-47B20ML85-PEG	
	57	82,5	-	RR-57B16ML83-PEG	RR-57B18ML83-PEG	RR-57B20ML83-PEG	
		84,5	-	RR-57B16ML85-PEG	RR-57B18ML85-PEG	RR-57B20ML85-PEG	
	67	82,5	-	RR-67B16ML83-PEG	RR-67B18ML83-PEG	RR-67B20ML83-PEG	
		84,5	-	RR-67B16ML85-PEG	RR-67B18ML85-PEG	RR-67B20ML85-PEG	
VERSION WITH FLANGE							
PE-HD GREEN	47	85,8	55	RRF-40B16ML86-PEG	RRF-40B18ML86-PEG	RRF-40B20ML86-PEG	50
	57	85,8	65	RRF-50B16ML86-PEG	RRF-50B18ML86-PEG	RRF-50B20ML86-PEG	
	67	85,8	75	RRF-60B16ML86-PEG	RRF-60B18ML86-PEG	RRF-60B20ML86-PEG	



External diameter

CHARACTERISTICS:

- Reduced noise level
- Very low friction coefficient
- No liquid absorption
- Excellent wear and chemical resistance
- Completely closed structure, easier to clean and disinfect
- Watertight

RUBBER MATERIAL: TPR

Chains & sprockets	Wear strips	Side guide brackets & accessories	Levelers
Modular belts & sprockets	Chain & belt return systems	Frame & structure supports	Bearing supports
Curves & tracks	Side guide solutions	Miscellaneous products	Related information

5 1 0 9 0 a

FLANGES FOR RETURN ROLLERS

www.SystemPlastSmartGuide.com



Click here for related information.

GUIDE FLANGE

CHARACTERISTICS:

- No liquid absorption.
- Excellent wear and chemical resistance.

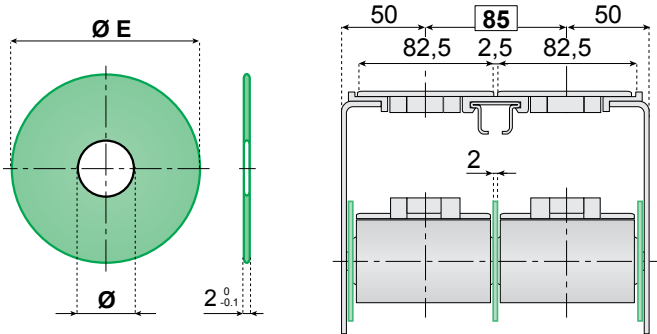

GUIDE FLANGE

MATERIAL	Ø E	FOR PIN				
		Ø 14	Ø 16	Ø 18	Ø 20	
ITEM DESCRIPTION						
PP GREEN	50	F-50B14ML2-PPG <small>MOQ</small>	F-50B16ML2-PPG <small>MOQ</small>	F-50B18ML2-PPG	F-50B20ML2-PPG	100
	60	F-60B14ML2-PPG <small>MOQ</small>	F-60B16ML2-PPG <small>MOQ</small>	F-60B18ML2-PPG	F-60B20ML2-PPG	
	70	F-70B14ML2-PPG	F-70B16ML2-PPG	F-70B18ML2-PPG	F-70B20ML2-PPG	
	100	-	-	F-100B18ML2-PPG	F-100B20ML2-PPG	

MOQ Min. order quantity: 250 pcs.

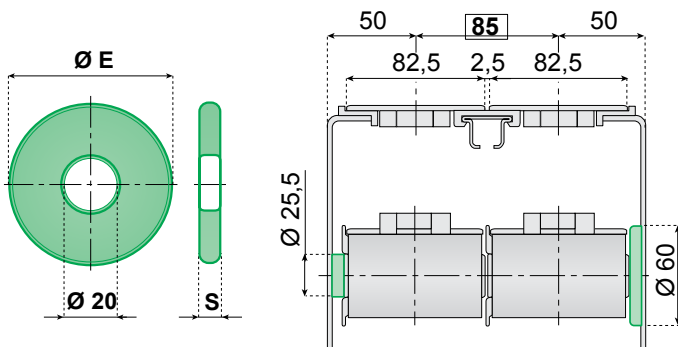

GUIDE FLANGE

MATERIAL	Ø E	S	FOR PIN	
			Ø 20	
ITEM DESCRIPTION				
PP GREEN	25,5	7,25	F-26B20ML7-PPG	100
	60	7,25	F-60B20ML7-PPG	
	90	5	F-90B20ML5-PPG	

Chains & sprockets	Wear strips	Side guide brackets & accessories	Levelers
Modular belts & sprockets	Chain & belt return systems	Frame & structure supports	Bearing supports
Curves & tracks	Side guide solutions	Miscellaneous products	Related information

5 1 1 1 0 a

SOLID ROLLERS FOR CHAINS AND BELTS

www.SystemPlastSmartGuide.com

Also available in PE Material, watertight version, go to:

5 1 0 8 0 a



Click here for related information.

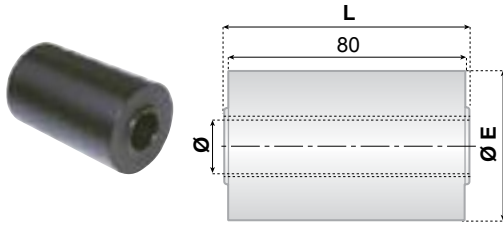

WATERTIGHT ROLLER

CHARACTERISTICS:

- Very low friction coefficient.
- No liquid absorption.
- Excellent wear and chemical resistance.
- Completely closed structure.
- Watertight.

WATERTIGHT ROLLER

MATERIAL	Ø E	L	FOR ROD				ITEM DESCRIPTION	50
			Ø 15	Ø 16	Ø 18	Ø 20		
PE BLACK	40	82,5	R-40B15ML83-PEB-S	R-40B16ML83-PEB-S	R-40B18ML83-PEB-S	R-40B20ML83-PEB-S	50	
		84,5	R-40B15ML85-PEB-S	R-40B16ML85-PEB-S	R-40B18ML85-PEB-S	R-40B20ML85-PEB-S		
	50	82,5	R-50B15ML83-PEB-S	R-50B16ML83-PEB-S	R-50B18ML83-PEB-S	R-50B20ML83-PEB-S		
		84,5	R-50B15ML85-PEB-S	R-50B16ML85-PEB-S	R-50B18ML85-PEB-S	R-50B20ML85-PEB-S		
	60	82,5	R-60B15ML83-PEB-S	R-60B16ML83-PEB-S	R-60B18ML83-PEB-S	R-60B20ML83-PEB-S		
		84,5	R-60B15ML85-PEB-S	R-60B16ML85-PEB-S	R-60B18ML85-PEB-S	R-60B20ML85-PEB-S		



External diameter

MOQ Min. order quantity: 100 pcs.

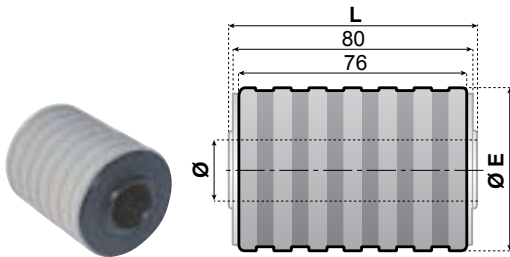

WATERTIGHT ROLLER WITH RUBBER

MATERIAL	Ø E	L	FOR ROD				ITEM DESCRIPTION	50
			Ø 15	Ø 16	Ø 18	Ø 20		
PE BLACK	47	82,5	RR-47B15ML83-PEB-S	RR-47B16ML83-PEB-S	RR-47B18ML83-PEB-S	RR-47B20ML83-PEB-S	50	
		84,5	RR-47B15ML85-PEB-S	RR-47B16ML85-PEB-S	RR-47B18ML85-PEB-S	RR-47B20ML85-PEB-S		
	57	82,5	RR-57B15ML83-PEB-S	RR-57B16ML83-PEB-S	RR-57B18ML83-PEB-S	RR-57B20ML83-PEB-S		
		84,5	RR-57B15ML85-PEB-S	RR-57B16ML85-PEB-S	RR-57B18ML85-PEB-S	RR-57B20ML85-PEB-S		
	67	82,5	RR-67B15ML83-PEB-S	RR-67B16ML83-PEB-S	RR-67B18ML83-PEB-S	RR-67B20ML83-PEB-S		
		84,5	RR-67B15ML85-PEB-S	RR-67B16ML85-PEB-S	RR-67B18ML85-PEB-S	RR-67B20ML85-PEB-S		



External diameter

RUBBER MATERIAL: TPR

MOQ Min. order quantity: 100 pcs.

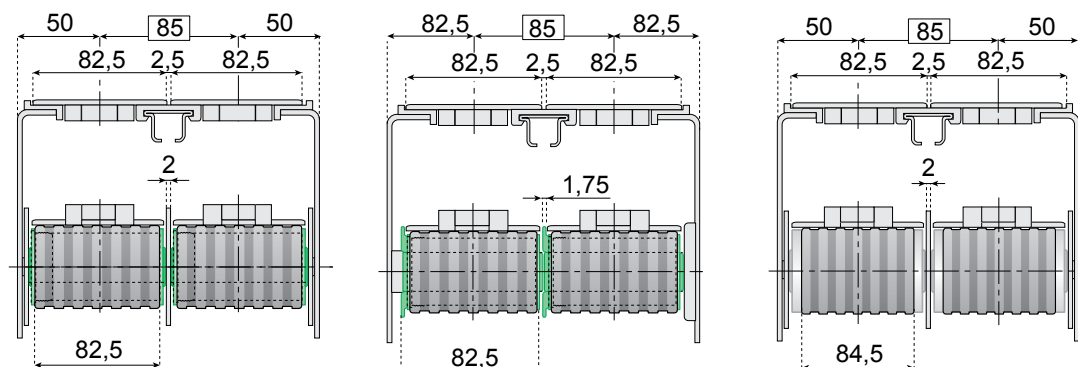

For flanges for return rollers, go to:

5 1 0 9 0 a

Chains & sprockets	Wear strips	Side guide brackets & accessories	Levelers
Modular belts & sprockets	Chain & belt return systems	Frame & structure supports	Bearing supports
Curves & tracks	Side guide solutions	Miscellaneous products	Related information

5 1 1 2 0 a

CHAIN RETURN COMPONENTS

www.SystemPlastSmartGuide.com



Click here for related information.



Information about this product is only available on our Smart Guide® website.

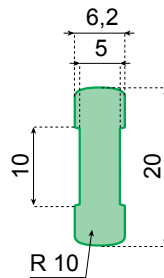
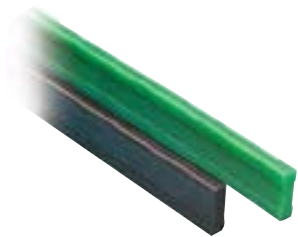
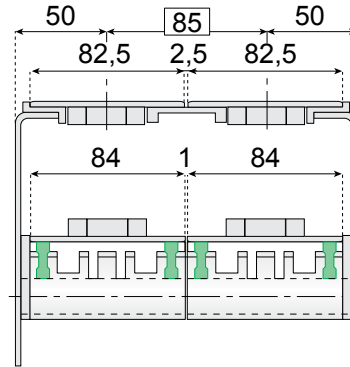

WEAR STRIP

MATERIAL	ITEM DESCRIPTION		
PE GREEN	VG-F206M-G-200	60 m	60 m
PE BLACK	VG-F206M-B-200	60 m	60 m
Nolu®-S	VG-F206M-NS-200	60 m	60 m

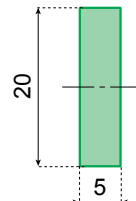
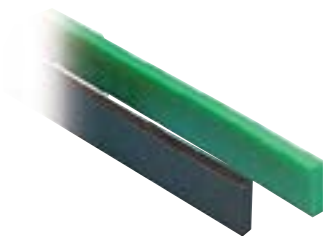

WEAR STRIP

MATERIAL	ITEM DESCRIPTION		
PE GREEN	VG-F205M-G-200	60 m	60 m
PE BLACK	VG-F205M-B-200	60 m	60 m

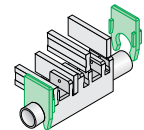
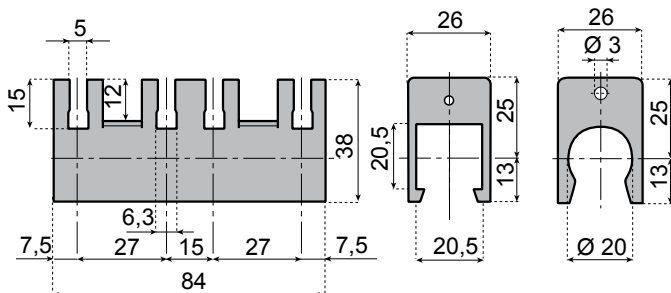

For change return components, go to:

5 1 1 3 0 a

SPACER FOR SERPENTINE

MATERIAL			
	20x20	Ø 20	
ITEM DESCRIPTION			
PA BLACK	SPT-84-S20C	SPT-84-R20C	100

For solutions for 101.6 (4") and 114.3 (4 1/2") top plates, go to: **5 1 1 6 0 a**

Chains & sprockets	Wear strips	Side guide brackets & accessories	Levelers
Modular belts & sprockets	Chain & belt return systems	Frame & structure supports	Bearing supports
Curves & tracks	Side guide solutions	Miscellaneous products	Related information

5 1 1 3 0 a

CHAIN RETURN COMPONENTS

www.SystemPlastSmartGuide.com

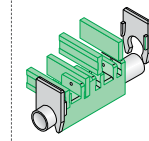

For chain return components, go to:

5 1 1 2 0 a



Click here for related information.

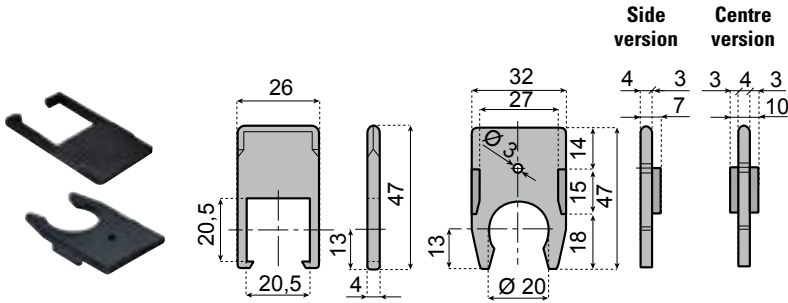

LITTLE WASHER

MATERIAL				
	ITEM DESCRIPTION			
PA BLACK	SPT-4L26-S20C	SPT-4L26S-R20C	SPT-4L26C-R20C	100

APPLICATION EXAMPLE

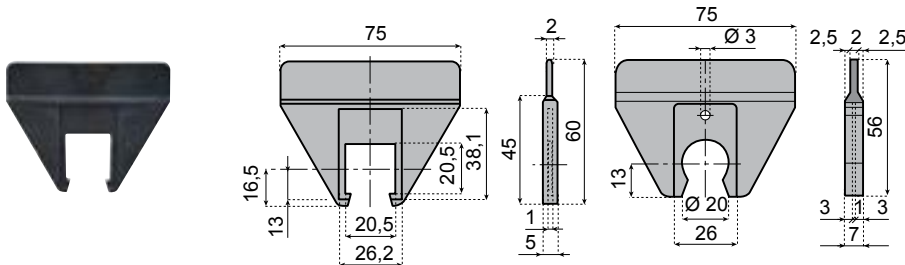
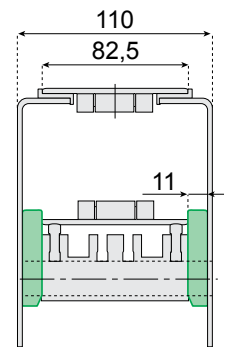
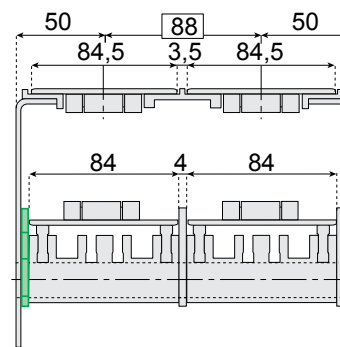
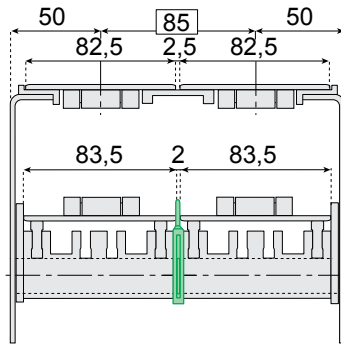
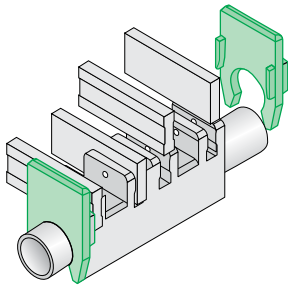

BIG STRIKER

MATERIAL			
	ITEM DESCRIPTION		
PA BLACK	SPT-2L75-S20C	SPT-2L75-R20C	100

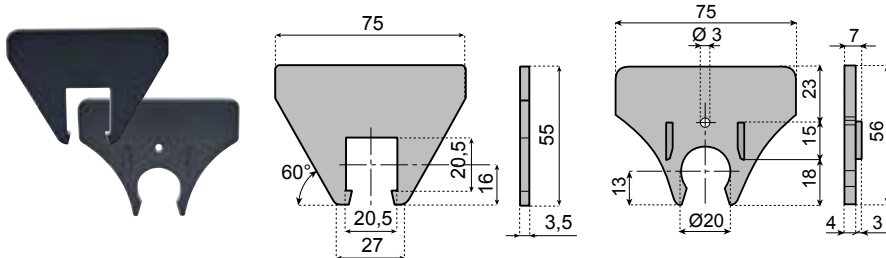

BIG STRIKER

MATERIAL			
	ITEM DESCRIPTION		
PA BLACK	SPT-4L75-S20C	SPT-4L75-R20C	100

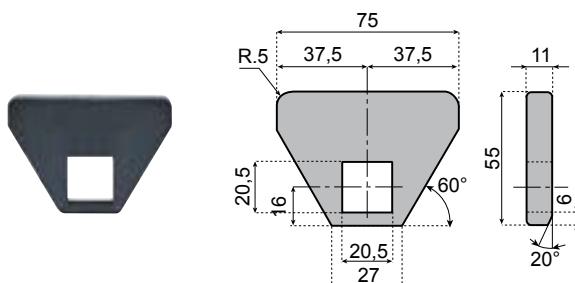

APPLICATION EXAMPLE

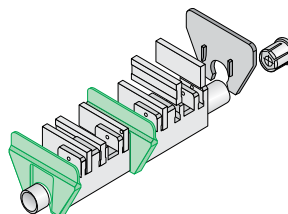

EXTRA STRIKER

MATERIAL		
	ITEM DESCRIPTION	
PA BLACK	SPT-11L75-S20	100

Chains & sprockets	Wear strips	Side guide brackets & accessories	Levelers
Modular belts & sprockets	Chain & belt return systems	Frame & structure supports	Bearing supports
Curves & tracks	Side guide solutions	Miscellaneous products	Related information

5 1 1 4 0 a

SERPENTINE RETURN SYSTEM

www.SystemPlastSmartGuide.com



Click here for related information.

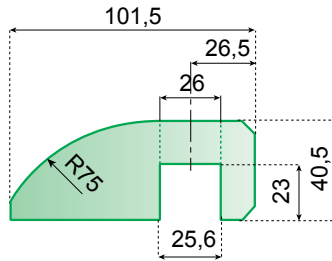

SLIDING SHOE

MATERIAL	ITEM DESCRIPTION	
PE GREEN	SHOE-53L102-S25C-PEG	100

USE: with spacers SPT-84-R20C.

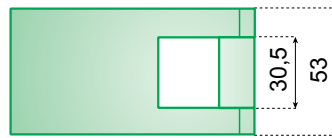

EXPANSION PLUG

COMPONENTS:

External part in reinforced polyamide. Conical insert in nickel plated brass.

Technical information:

Max. load for removal Kgf 300 (static conditions).

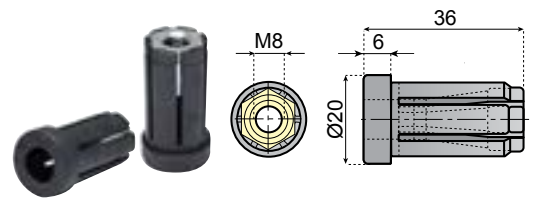
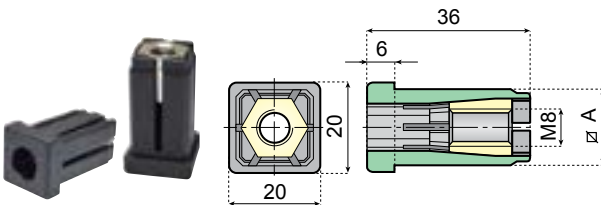

EXPANSION PLUG FOR SQUARE TUBES

MATERIAL	M8	FOR SQUARE TUBE \square	
	ITEM DESCRIPTION		
PA BLACK	TEE-S2015-BM8	20 x 20 x 1.5	100
	TEE-S2020-BM8	20 x 20 x 2	

EXPANSION PLUG FOR ROUND TUBES

MATERIAL	ITEM DESCRIPTION	FOR ROUND TUBE	
PA BLACK	TEE-R2015-BM8	Ø 20x1.5	100

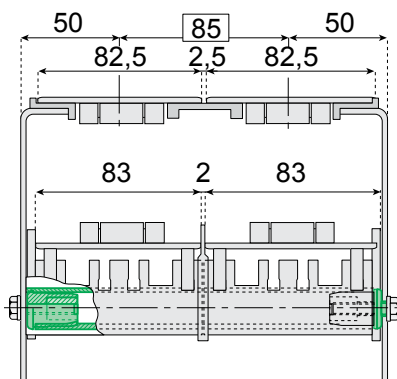

Chains & sprockets	Wear strips	Side guide brackets & accessories	Levelers
Modular belts & sprockets	Chain & belt return systems	Frame & structure supports	Bearing supports
Curves & tracks	Side guide solutions	Miscellaneous products	Related information

5 1 1 5 0 a

FLEXIBLE WIDTH SERPENTINE SYSTEM

www.SystemPlastSmartGuide.com



Click here for related information.

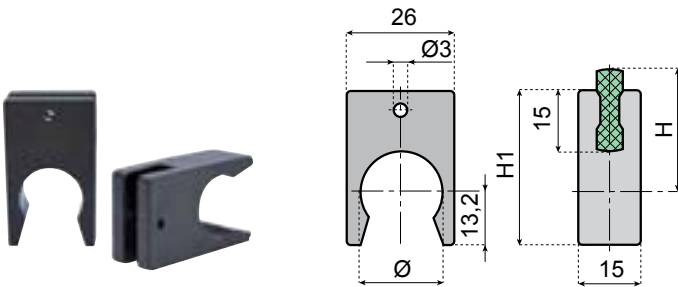

SINGLE SPACER SNAP-ON ASSEMBLY

MATERIAL	Ø 18	Ø 20	H	H1	
	ITEM DESCRIPTION				
PA BLACK	SPT-15R18C	-	34	42.5	100
	-	SPT-15R20C	30	38	

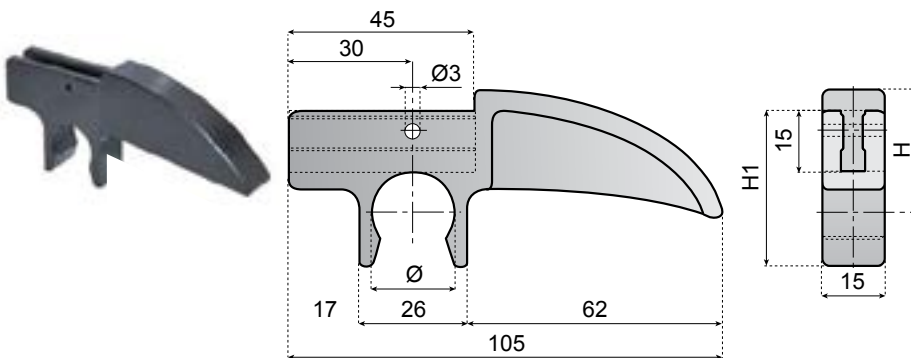

SHOE WEAR STRIP SNAP-ON ASSEMBLY

MATERIAL	Ø 18	Ø 20	H	H1	
	ITEM DESCRIPTION				
PA BLACK	SHOE-15L105-R18C-PAB	-	34	42,5	100
	-	SHOE-15L105-R20C-PAB	30	38	

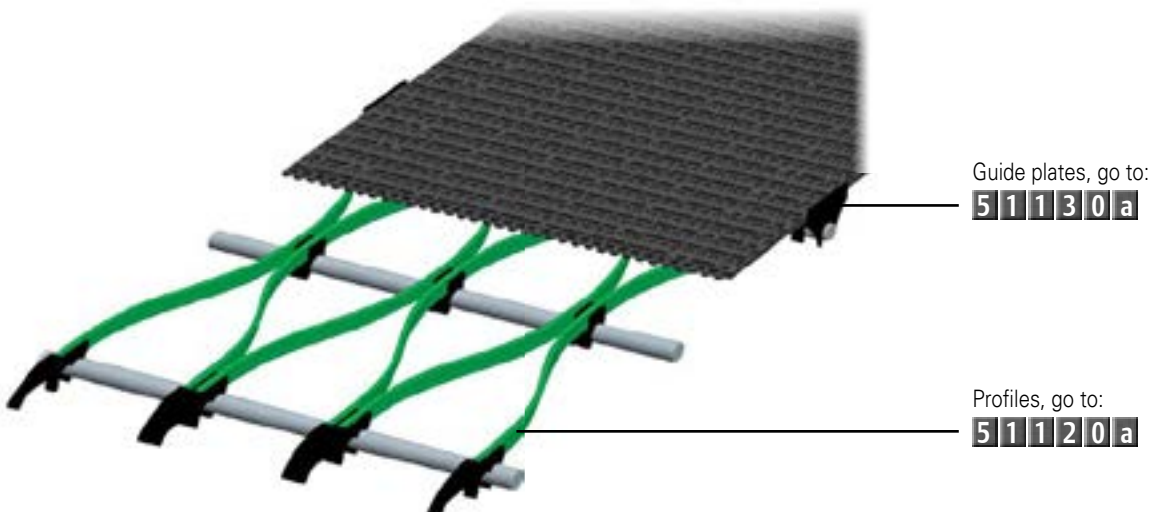

Chains & sprockets	Wear strips	Side guide brackets & accessories	Levelers
Modular belts & sprockets	Chain & belt return systems	Frame & structure supports	Bearing supports
Curves & tracks	Side guide solutions	Miscellaneous products	Related information

5 1 1 6 0 a

CHAIN RETURN COMPONENTS

www.SystemPlastSmartGuide.com



Click here for related information.

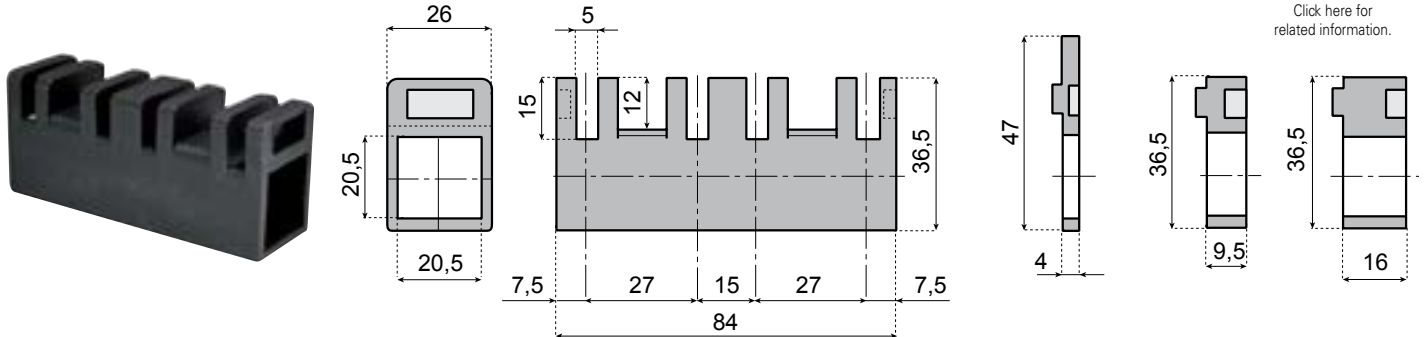

WASHER



MATERIAL					
	84	4	9.5	16	
ITEM DESCRIPTION					
PA BLACK	SPT-84-S20	SPT-4L26-S20	SPT-10L26-S20	SPT-16L26-S20	100

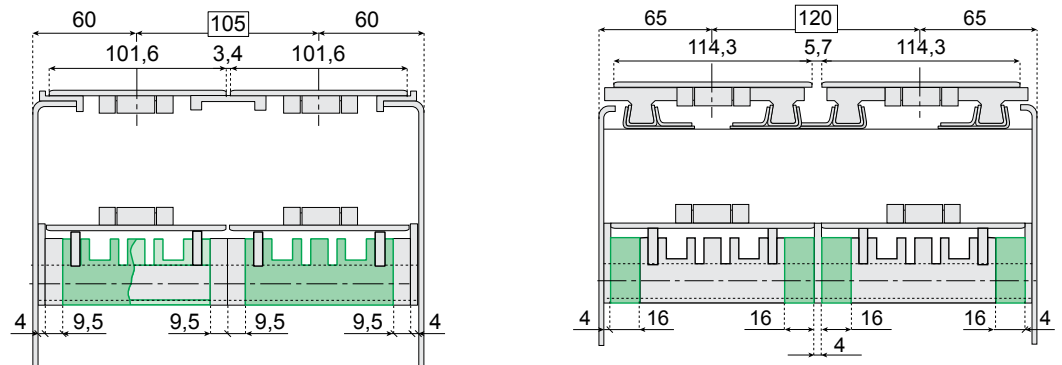

SLIDING SHOE



MATERIAL	FOR SQUARE SHAFT 20X20	
	ITEM DESCRIPTION	
PE BLACK	SHOE-84L68-S20-PEB	100



Information about this product is only available on our Smart Guide® website.

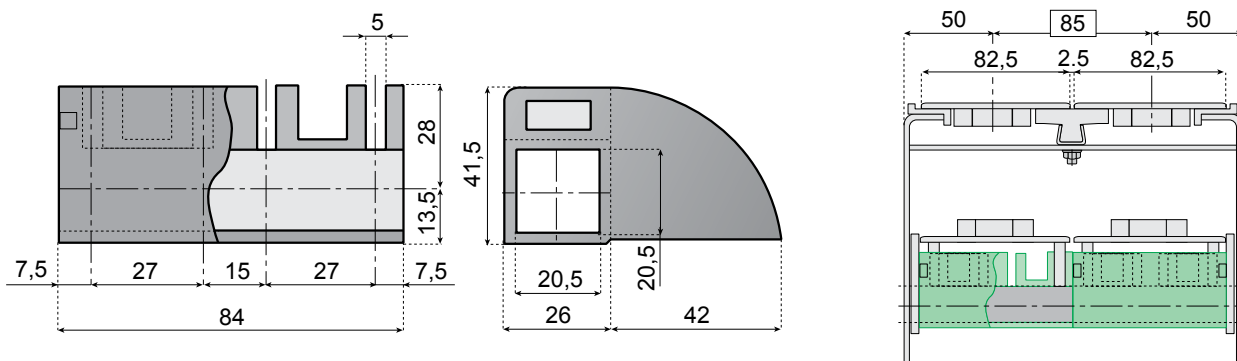

For standard solutions, go to: **5 1 0 6 0 a**

Chains & sprockets	Wear strips	Side guide brackets & accessories	Levelers
Modular belts & sprockets	Chain & belt return systems	Frame & structure supports	Bearing supports
Curves & tracks	Side guide solutions	Miscellaneous products	Related information

51170a

SLIDING SHOE

www.SystemPlastSmartGuide.com



Click here for related information.

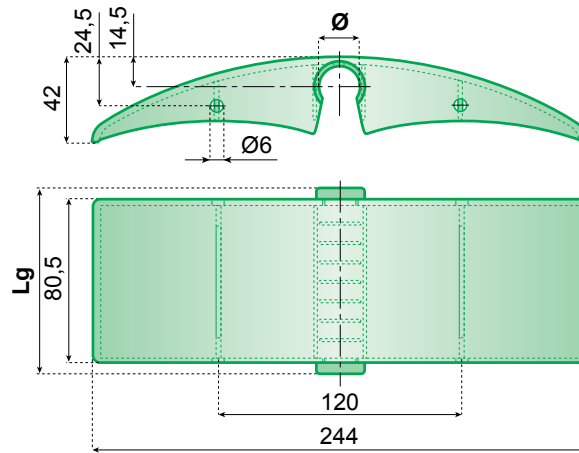

SNAP-ON SELF-ADJUSTING SLIDING SHOE

MATERIAL	Ø 18	Ø 20	LG	
	ITEM DESCRIPTION			
PE BLACK	SHOE-84L244-R18C-PEB	SHOE-84L244-R20C-PEB	84	50
	-	SHOE-85L244-R20C-PEB	85	
	-	SHOE-88L244-R20C-PEB	88	
PE GREEN	SHOE-84L244-R18C-PEG	SHOE-84L244-R20C-PEG	84	
	-	SHOE-85L244-R20C-PEG	85	
	-	SHOE-88L244-R20C-PEG	88	

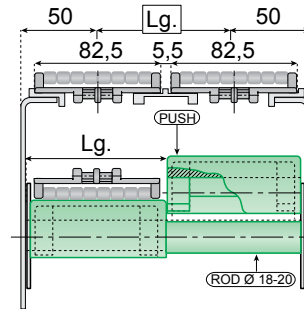

MOQ Min. order quantity: 300 pcs.



MATERIAL	ITEM DESCRIPTION	
PE GREEN	SHOE-89L162-S25C-PEG	100

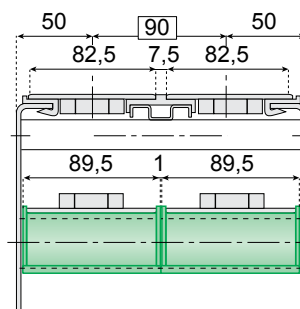
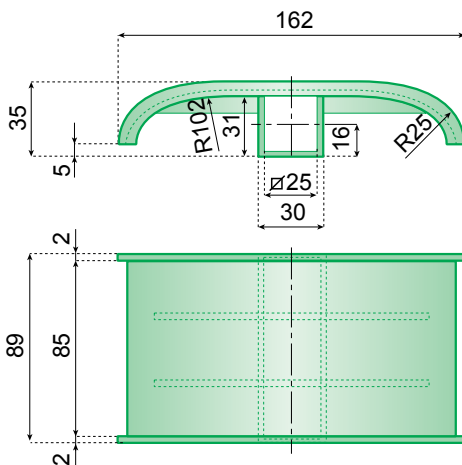

Chains & sprockets	Wear strips	Side guide brackets & accessories	Levelers
Modular belts & sprockets	Chain & belt return systems	Frame & structure supports	Bearing Supports
Curves & tracks	Side guide solutions	Miscellaneous products	Related information

Item description	Page code	Item description	Page code	Item description	Page code	Item description	Page code
1400..D	11590a	820..DS	11200a	BKR-69W31LP..	53525b	CL-RD10-PD..	51650a
1400..R	11590a	820..RM	11200b	BKR-69W31LS..	53525a	CL-RD12-P.	51640a
1400V..R	11600a	820..RMS	11200b	BKR-69W44P.	53545a	CL-RD12-P258M	51650a
1700..D	11550a	820..RS	11200b	BKR-69W44S..	53545a	CL-RD12-PD..	51650a
1700..DMS	11550a	820..W	11050a	BKR-70W43P..	53535b	CL-RD14-P.	51640a
1700..R	11550a	820..W-HDL	11040c	BKR-72W43P..	53535a	CL-RD14-P258M	51650a
1700..RB	11560a	820..WL	11050a	BKR-72W43S..	53535a	CL-RD20-P.	51640a
1700..RC	11560a	820..WM	11050b	BKR-75W43LP..	53535b	CL-RD8-P.	51640a
1700..RM	11550a	820..WMS	11050b	BKR-77W43P..	53535a	CL-RD8-P258M	51650a
1700..RMS	11550a	820..WS	11050a	BKR-77W43S..	53535a	CL-RD8-PD..	51650a
1874..	11140a	821..D	11320b	BKR-84W31LP.	53525b	CL-RD8-PF	51650a
1874..	11450a	821..R	11320b	BKR-85W44P.	53545b	CON..	50600a
2080..DM	30027a	821..W	11320b	BKR-87W31LP..	53525b	CON-H7816M-S	51690a
2080..DMS	30027a	821..WMS	11320b	BKR-88W43P..	53535b	CON-H8716M-S	51700a
2120..	30160a	878..D	11270a	BKR-93W43LP..	53535b	CRBFTRS..	56044a
2120..DS-PK2	30160c	878..RB	11270a	BKZ-154-SS	53580a	CRBFTRS..	56074a
2122..	30166a	878..RC	11270a	BPS-4020..	54040a	CS..	56100a
2123..DMS	30065a	880..DM	11260c	BUSH-R200..	54040a	CSHOE..	50600a
2123..RMS	30065a	880..DMS	11260a	CAP-10M..	53605a	DS-25M52	54520a
2124..	30165a	880..DS	11260a	CAP-25M..	54530a	DS-30M52	54520a
2190..	30235a	880..RM	11260c	CAP-30M..	54530a	DTS..	53600a
2250..	30395a	880..RMS	11260a	CAP7023-P-YT	56300b	F-100..	51090a
2251..	30550a	880..RS	11260a	CAP7023-B30M..	56300b	F-26..	51090a
2253RT..DS	30395d	880T..W	11260d	CAP8437-P-YT	56300b	F-50..	51090a
2256..	30740a	880T..WMS	11260d	CAP-8437-B40M..	56300b	F-60..	51090a
2260..	30715a	881..DMS	11090a	CAP-50M..	54530a	F-70..	51090a
2260..DS-PK2	30715b	881..DS	11090a	CC-16..	53610a	F-90..	51090a
2351..	30760a	881..RMS	11090a	CC-19-12MK-12MK	53620a	FT-HDL..	54560a
2500..	30615a	881..RS	11090a	CC-20..	53620a	FT-LOCK..	54570a
2508..	30640a	881T..W	11090b	CC-25-12MK..	53620a	FT-MAG..	54570a
2630..	30650a	881T..WMS	11090b	CC-25-14M..	53615a	GLSHOE-S330	50600b
500..	56300b	882..DMS	11300a	CC-25-15M..	53615a	GNP..	56300a
515..DMS	11130a	882..DS	11300a	CC-25-16M..	53615a	GP..	54540a
515..RMS	11130a	882..RMS	11300a	CC-25-18M..	53615a	GRINGK..	11090d
600..RM	11580a	882..RS	11300a	CC-25-20M..	53615a	GRP..EPDM	11440b
800..DMS	11120a	882T..W	11300b	CC-42-12MK..	53620a	GRP..NBR	11440a
800..DMS-F	11120b	BCK..	50600a	CC-42-12MQ..	53630a	GRPK..NBR	11440a
800..DMS-FSS	11120b	BEC-19	56044a	CC-52-R..	53650a	GRPN..NBR	11430a
800..RMS	11120a	BEC-24	56074a	CC-52-S..	53645a	GRSHOE-S330	50600b
800..WMS	11120b	BEO-19	56044a	CJ..	54520a	HDL-117..	54560a
800..FSS	11120b	BEO-24	56074a	CL..	56090a	HDL-120..	54560a
814..DMS	11150b	BK-47W44..	53545b	CL-1020S	52550a	HDL-94..	54560a
814..RMS	11150b	BK-49W31L	53525b	CL-1540S	52530a	HNG..	54550a
815..D	11040a	BK-50W43	53535b	CL-6065X38	50600a	HUB110..	11270a
815..DMS	11040b	BK-55W43L	53535b	CL-CON-P..	51600a	IND-142B..	53635a
815..DMS-F	11090d	BKE-85W22..	53555a	CL-CON-P25..	51630a	IND-350R..	53635a
815..DS	11040a	BKF-35W31L..	53555a	CL-CON-PD..	51610a	KMD01..	50050a
815..DS-K2	11040c	BKF-61W38..	53560a	CL-CON-R	51820a	KMD02..	50050a
815..FSS	11090d	BKF-65W30L..	53555a	CL-D..	51660a	KMD03..	50020a
815..RMS	11040b	BKF-66W31L..	53515a	CL-H45S	52521a	KMD04..	50050a
8157..DMS	11100a	BKF-66W31L..	53515b	CL-H5210..	52594a	KMD05..	50030a
8157..DMS-F	11100b	BKF-79W30..	53555a	CL-H7816M..	51690a	KMD06..	50020a
8157..FSS	11100b	BKF-89W38..	53560a	CL-H8716M..	51700a	KMD07..	50020a
820..D	11200a	BKL..SS	53580a	CL-H9014M..	51680a	KMD08..	50020a
820..DM	11200b	BKR-67W44P.	53545b	CL-RD10-P.	51640a	KMD09..	50020a
820..DMS	11200a	BKR-69W31LP..	53525a	CL-RD10-P258M	51650a	KMD10..	50020a

Legend

Codes ending with .. indicate a group of item descriptions all starting with the code listed. Example: 2122.. (all item descriptions starting with 2122).
 Codes with .. in the middle indicate a group of item descriptions starting and ending with the codes listed. Example 2251..RS (all item descriptions starting with 2251 and ending with RS). **Information about item descriptions, printed in blue, is only available on our website: www.SystemPlastSmartGuide.com**

Chains & sprockets	Wear strips	Side guide brackets & accessories	Levelers
Modular belts & sprockets	Chain & belt return systems	Frame & structure supports	Bearing Supports
Curves & tracks	Side guide solutions	Miscellaneous products	Related information

Item description	Page code	Item description	Page code	Item description	Page code	Item description	Page code
KMD11..	50030a	LA110..	55600a	LFB2253FT..	30330a	LFG2251FT-PT.VG-3	30490d
KMD12..	50030a	LA120E-02B..	55645a	LFB2253RT..	30397a	LFG2251FT-PT.VGS	30495d
KMD21..	50040a	LA123H-02B..	55645a	LFB2256..	30730a	LFG2251FT-PT.VGS-2	30495d
KMD22..	50040a	LA40..	55525a	LFB2256..VG	30735a	LFG2251FT-PT.VGS-3	30495d
KMD23..	50040a	LA50..	55540a	LFG1700	11530a	LFG2251FT-TAB..	30710a
KMD24..	50080a	LA60..	55555a	LFG1702	11530a	LFG2251LBP..	30500a
KMD25..	50080a	LA60-01..	55630a	LFG1710..	11540a	LFG2252PT..	30481a
KMD26..	50080a	LA60H-01..	55630a	LFG1710-CTAB..	11540a	LFG2253FT..	30330a
KMD27..	50080a	LA60S-01..	55630a	LFG2120FG..	30070a	LFG2260FT-M..	30700a
KMD28..	50080a	LA80..	55570a	LFG2120FT..	30050a	LFG2351..	30745a
KMD31..	50040a	LA80H..	55570a	LFG2120FT-PT..	30060b	LFG2351..VG	30755a
KMD32..	50040a	LA80S..	55780a	LFG2120FT-PT..VG-2	30100d	LFG2451TAB..	30750a
KMD33..	50040a	LAF100SH-01..	55630a	LFG2120FT-PT..VG-3	30100d	LFG2508FTS..	30620a
KMD37..	50040a	LAF123H..	55840a	LFG2120FT-PT2..	30060b	LFG2551..	30745a
KMD39..	50060a	LAF123H-02B..	55660a	LFG2123FG..	30065a	LFG2630FTS..	30645a
KMD40..	50060a	LAS100..	55615a	LFG2250FG..	30360a	LFG2651TAB..	30750a
KMD41..	50060a	LAS120..	55615a	LFG2250FG-M..	30700a	LFG-COMB2500..	30615a
KMD42..	50060a	LAS80..	55615a	LFG2250FG-PT..	30360c	LFM30..	55750a
KMD48..	50060a	LAX100..	55810a	LFG2250FG-PT2..	30360c	LFM40..	55750a
KMD52..	50060a	LAX102..	55795a	LFG2250FT..	30325a	LFM50..	55750a
KMD61..	50050a	LAX123..	55840a	LFG2250FT..VG	30370a	LFW1400..	11590a
KMD62..	50050a	LAX123-02B..	55660a	LFG2250FT..VG-2	30370b	LFW1400..	11600a
KMD64..	50101a	LB100	55735a	LFG2250FT..VG-3	30370b	LFW1431..	11590a
KMD66..	50101a	LB150	55735a	LFG2250FT..VGS	30380a	LFW1700	11530a
KMD68..	50070a	LB200	55735a	LFG2250FT..VGS-2	30380b	LFW1701-TAB	11530a
KMD71..	50070a	LB80	55735a	LFG2250FT..VGS-3	30380b	LFW1702	11530a
KMD78..	50070a	LF1700	11530a	LFG2250FT-K330	30310a	LFW1710..	11540a
KMD82..	50070a	LF1701-TAB	11530a	LFG2250FT-P.VGS	30380c	LFW1710-CTAB..	11540a
KMD84..	50101a	LF1702	11530a	LFG2250FT-P.VGS-2	30380c	LFW600..	11570a
KMD85..	50101a	LF1843 SS TAB..	11470a	LFG2250FT-P.VGS-3	30380c	LFW600F	11580a
KMD86..	50101a	LF1843 TAB..	11470a	LFG2250FT-PT..	30335b	LFW631 TAB	11580a
KMD87..	50101a	LF820..	11190a	LFG2250FT-PT..VG	30370d	LMM120..	55720a
KMD90..	50091a	LF820P..	11190a	LFG2250FT-PT..VG-2	30370d	LMM80..	55720a
KMD91..	50091a	LF821..	11320a	LFG2250FT-PT..VG-3	30370d	LMP125..	55705a
KMD92..	50091a	LF8257..	11310a	LFG2250FT-PT.VGS	30380d	LMP80..	55705a
KMD93..	50091a	LF828..	11210a	LFG2250FT-PT.VGS-2	30380d	LMPH123..	55735a
KMD96..	50091a	LF831..	11190a	LFG2250FT-PT.VGS-3	30380d	LSHOE-S330	50600b
KMD97..	50101a	LF843..	11460a	LFG2250FT-PT2..	30335b	LSS100..	55675a
KNF-30H21..	54610a	LF845..	11460a	LFG2250FT-PT-K330	30310a	LSS125..	55675a
KNF-40H26..	54610a	LF877TAB..	11230a	LFG2250FT-TAB..	30710a	LSS50..	55675a
KNF-50H32..	54610a	LF878TAB..	11230a	LFG2251FT..	30440a	LSS75..	55675a
KNF-50H39..	54600a	LF879..	11240a	LFG2251FT.VG	30490a	LSSC100..	55690a
KNF-50H40..	54600a	LF879P..	11240b	LFG2251FT.VG-2	30490b	LSSC125..	55690a
KNF-50H41..	54600a	LF879M..	11220a	LFG2251FT.VG-3	30490b	LSSC75..	55690a
KNF-50H56..	54600a	LF879TAB..	11230a	LFG2251FT.VGS	30495a	SNB2080..	30029a
KNF-53H45..	54600a	LF880..	11240a	LFG2251FT.VGS-2	30495b	NB2120..	30175a
KNF-80H51..	54600a	LF8800P..	11240b	LFG2251FT.VGS-3	30495b	SNB2120..	30175a
KNM-20H13..	54610a	LF880M..	11220a	LFG2251FT-M..	30700a	NGD1873TAB..VG	11420a
KNM-25H16..	54610a	LF880TAB..	11230a	LFG2251FT-P.VG	30490c	NGE1400..	11590a
KNM-30H21..	54610a	LF882M..	11280a	LFG2251FT-P.VG-2	30490c	NGE1431..	11590a
KNM-40H26..	54610a	LF882TAB..	11290a	LFG2251FT-P.VG-3	30490c	NGE1700	11530a
KNM-50H32..	54610a	LFB2080FT..	30025a	LFG2251FT-P.VGS	30495c	NGE1701-TAB	11530a
KNM-50H40..	54600a	LFB2120FG..	30070a	LFG2251FT-P.VGS-2	30495c	NGE1702	11530a
LA100..	55585a	LFB2120FT..	30050a	LFG2251FT-P.VGS-3	30495c	NGE1863 TAB..	11490a
LA100..	55825a	LFB2250FG..	30360a	LFG2251FT-PT.VG	30490d	NGE1863SS TAB..	11490a
LA100-SH..	55810a	LFB2250FT..	30325a	LFG2251FT-PT..VG-2	30490d	NGE1873SS TAB..	11470a

Legend

Codes ending with .. indicate a group of item descriptions all starting with the code listed. Example: 2122.. (all item descriptions starting with 2122).
 Codes with .. in the middle indicate a group of item descriptions starting and ending with the codes listed. Example 2251..RS (all item descriptions starting with 2251 and ending with RS). **Information about item descriptions, printed in blue, is only available on our website: www.SystemPlastSmartGuide.com**

Chains & sprockets	Wear strips	Side guide brackets & accessories	Levelers
Modular belts & sprockets	Chain & belt return systems	Frame & structure supports	Bearing Supports
Curves & tracks	Side guide solutions	Miscellaneous products	Related information

Item description	Page code	Item description	Page code	Item description	Page code	Item description	Page code
NGE1873SS TAB..GS	11440b	NGE2250FG-PT.T	30350a	NGE880TAB..VAC43X2	11235a	RF-21B6..	52680a
NGE1873SS TAB..GS..	11440a	NGE2250FG-PT2..	30360c	NGE882LBP TAB..	11360a	RF-24B6..	52680a
NGE1873SS TAB..VG	11420a	NGE2250FT..	30325a	NGE882LBP..	11360a	RF-40..86-PEG	51080a
NGE1873SS TAB..VG85QH8.5	11425a	NGE2250FT-K330	30310a	NGE882M..	11280a	RF-41..B	51020a
NGE1873TAB..	11470a	NGE2250FT-P..	30335a	NGE882M..VG	11400a	RF-41..G	51060a
NGE1873TAB..GS	11440b	NGE2250FT-P2..	30335a	NGE882TAB..	11290a	RF-47..G	51030a
NGE1873TAB..GS..	11440a	NGE2250FT-PT..	30335b	NGE882TAB..VG	11400a	RF-50..28-PEG	51040a
NGE1873TAB..VG	11420a	NGE2250FT-PT.T	30320a	NGE-S-K38..	11330a	RF-50..43-PEG	51050a
NGE2080FT..	30025a	NGE2250FT-PT2..	30335b	PAB-COMB2500..	30615a	RF-50..86-PEG	51080a
NGE2120FG..	30070a	NGE2250FT-PT-K330	30310a	PC-125110..	53640a	RF-50..B	51030a
NGE2120FG-P..	30075a	NGE2250FT-PT-K330T	30320a	PC-25..	53610a	RF-60..43-PEG	51050a
NGE2120FG-P2..	30075a	NGE2250FT-TAB..	30710a	PC-25T..	54530a	RF-60..86-PEG	51080a
NGE2120FG-PT..	30075b	NGE2251FT..	30440a	PC-30T..	54530a	RF-60..G	51030a
NGE2120FG-PT2..	30075b	NGE2251FT-K330	30420a	PC-9075..	53635a	RG-105H..	52570a
NGE2120FT..	30030a	NGE2251FT-M..	30700a	PC-KIT	53640a	RG-105H49..3000A	52572a
NGE2120FT..	30050a	NGE2251FT-PT..	30450b	PC-KIT-0M	53605a	RG-105H49..3000S	52571a
NGE2120FT..GB	30120a	NGE2251FT-PT.T	30430a	PC-KIT-19M	53605a	RG-105H49..348	52590a
NGE2120FT..GB-2	30120b	NGE2251FT-PT.TL	30430a	PCO-H7816M-B	51690a	RG-105H52..3000S	52594a
NGE2120FT..GB-3	30120b	NGE2251FT-PT-K330	30420a	PCO-H8716M-B	51700a	RG-105H81..3000A	52572a
NGE2120FT..VG50	30100a	NGE2251FT-TAB..	30710a	PCO-H9014M-G	51680a	RG-105H81..3000S	52571a
NGE2120FT..VG50-2	30100b	NGE2251LBP..	30500a	P-D..	51830a	RG-165..	52520a
NGE2120FT..VG50-3	30100b	NGE2251LBP-P..	30500b	PE..	51830a	RG-210H50..	52570a
NGE2120FT..VGS50	30105a	NGE2252FT..	30445a	PEN-H7816M-B	51690a	RG-210H50..3000A	52572a
NGE2120FT-P..	30060a	NGE2252FT..	30420a	PEN-H8716M-B	51700a	RG-210H50..3000S	52571a
NGE2120FT-P..VG50	30100c	NGE2252FT-PT..	30420a	PEN-H9014M-G	51680a	RG-240..	52521a
NGE2120FT-P2..	30060a	NGE2253FT..VAC43	30397n	PF..	51830a	RG-240H45..3000S	52530a
NGE2120FT-PT..	30030b	NGE2260FT-M..	30700a	PG..	51830a	RG-86H..	52570a
NGE2120FT-PT..	30060b	NGE600..	11570a	PK-D12M110	51830a	RG-86H49..3000A	52572a
NGE2120FT-PT..T	30045a	NGE820..	11190a	PM10..	51830a	RG-86H49..3000S	52571a
NGE2120FT-PT..VG50	30100d	NGE820P..	11190a	PMB..	54530a	RG-86H49..348	52590a
NGE2120FT-PT2..	30060b	NGE821..	11320a	PP1873SS TAB..GS..	11440b	RG-86H81..3000A	52572a
NGE2120LBP..	30110a	NGE821..VG	11410a	PP878TAB..GS..	11430b	RG-86H81..3000S	52571a
NGE2120M..	30720a	NGE821LBP..	11370a	PPG2500RR..	30610a	RG-86H81..3000S	52571a
NGE2120RF..	30108a	NGE8257..	11310a	R-26..B	51020a	RG..	52550a
NGE2121FT..	30030a	NGE8257..VG	11410a	R-26..G	51060a	RGC18-86H49..	52592a
NGE2121FT..	30055a	NGE8257LBP..	11370a	R-40..83-PEB-S	51110a	RGC20-105H49..	52592a
NGE2121FT-PT..	30030b	NGE828..	11210a	R-40..83-PEG	51080a	RGC32-86H49..	52593a
NGE2122FG..	30073a	NGE831..	11190a	R-40..85-PEG	51080a	RGC33-105H49..	52593a
NGE2124FT..	30030a	NGE831..VG	11380a	R-41..B	51020a	RH-45..	54620a
NGE2124FT..VG	30090a	NGE831LBP..	11340a	R-41..G	51060a	RH-65..	54620a
NGE2124FT-PT..	30030b	NGE863..	11460a	R-49..G	51040a	RH-80..	54620a
NGE2124FT-PT..VG	30090a	NGE878LBP..	11350a	R-50..27-PEG	51040a	RPAD10004	55810a
NGE2190FG..	30230a	NGE878TAB..GS..	11430b	R-50..41-PEG	51050a	RPAD10108	55600a
NGE2190FG..	30220a	NGE878TAB..GS..	11430a	R-50..43-PEG	51050a	RPAD11207	55615a
NGE2190FG-PT..	30220a	NGE878TAB..VG	11390a	R-50..83-PEB-S	51110a	RPAD11207	55645a
NGE2190FT..	30210a	NGE879..	11240a	R-50..83-PEG	51080a	RPAD12208	55660a
NGE2190FT..	30200a	NGE879LBP TAB..	11350a	R-50..85-PEB-S	51110a	RPAD12208	55645a
NGE2190FT-PT..	30200a	NGE879M..	11220a	R-50..85-PEG	51080a	RPAD12208	55840a
NGE2190FT-PT..T	30215a	NGE879M..VG	11380a	R-60..41-PEG	51050a	RPAD12506	55705a
NGE2250FG..	30360a	NGE879TAB..	11230a	R-60..83-PEB-S	51110a	RPAD12506	55720a
NGE2250FG-K330	30340a	NGE879TAB..VG	11390a	R-60..83-PEG	51080a	RPAD3206	55525a
NGE2250FG-M..	30700a	NGE880..	11240a	R-60..85-PEB-S	51110a	RPAD4206	55540a
NGE2250FG-P..	30360b	NGE8800..	11240b	R-60..85-PEG	51080a	RPAD5207	55630a
NGE2250FG-P2..	30360b	NGE8800P..	11240b	R-9B4..	52680a	RPAD5306	55555a
NGE2250FG-P-K330	30340a	NGE880M..	11220a	RF-11B4..	52680a	RPAD7207	55615a
NGE2250FG-PT..	30360c	NGE880TAB..	11230a	RF-17B6..	52680a	RPAD7207	55570a

Legend

Codes ending with .. indicate a group of item descriptions all starting with the code listed. Example: 2122.. (all item descriptions starting with 2122).
 Codes with .. in the middle indicate a group of item descriptions starting and ending with the codes listed. Example 2251..RS (all item descriptions starting with 2251 and ending with RS). **Information about item descriptions, printed in blue, is only available on our website: www.SystemPlastSmartGuide.com**

Chains & sprockets	Wear strips	Side guide brackets & accessories	Levelers
Modular belts & sprockets	Chain & belt return systems	Frame & structure supports	Bearing Supports
Curves & tracks	Side guide solutions	Miscellaneous products	Related information

Item description	Page code	Item description	Page code	Item description	Page code	Item description	Page code
RPAD8006	55705a	SPT-10..	51160a	TE-R..	55765a	TTM97..	50101a
RPAD8006	55720a	SPT-11L..	51130a	TE-S..	55765a	TTMK..	50565a
RPAD9308	55585a	SPT-15..	51150a	TME..	52670a	TUBE-R10S-6000	53605a
RPAD9308	55795a	SPT-16..	51160a	TME-K..	52671a	TWP-S4030..	55765c
RPAD9308	55615a	SPT-2..	51130a	TOP-20P	53585a	UC..	56300a
RPAD9308	55825a	SPT-4..	51130a	TOP-23P..	53585a	UCFB..	56140a
RR-47..83-PEB-S	51110a	SPT-4..	51160a	TOP-23S..	53585a	UCFG..	56080a
RR-47..83-PEG	51080a	SPT-84..	51120a	TOP-24P..	53585a	UCFH..	56020a
RR-47..85-PEB-S	51110a	SPT-84..	51160a	TOP-24S..	53585a	UCFH..	56030a
RR-47..85-PEG	51080a	SQL..	56130a	TOP-25S..	53585a	UCFH..	56042a
RR-57..27-PEG	51040a	SR800..	11030b	TOP-40P..	53585a	UCFH..ME..	56040a
RR-57..41-PEG	51050a	SS802..	11120a	TOP-40S..	53585a	UCFHXX..	56042a
RR-57..43-PEG	51050a	SS812..	11030a	TOP-60S..	53585a	UCFL..	56020a
RR-57..83-PEB-S	51110a	SS881M..	11060a	TOP-90S..	53585a	UCFL..ME..	56040a
RR-57..83-PEG	51080a	SS881MO..	11060a	TTM01..	50050a	UFLX..	56020a
RR-57..85-PEB-S	51110a	SSA805..	11030b	TTM02..	50050a	UFLQ..	56072a
RR-57..85-PEG	51080a	SSA815..	11030b	TTM03..	50020a	UFLZ..ME..	56040a
RR-67..41-PEG	51050a	SSA810..	11080a	TTM04..	50050a	VG-009M-01	51630a
RR-67..83-PEB-S	51110a	SSA881OTAB..	11070a	TTM05..	50030a	VG-011..	51620a
RR-67..83-PEG	51080a	SSE515..	11130a	TTM06..	50020a	VG-012-01	51620a
RR-67..85-PEB-S	51110a	SSE805..	11120a	TTM07..	50020a	VG-013..	51620a
RR-67..85-PEG	51080a	SSE805..VG	11180a	TTM08..	50020a	VG-016-02	51630a
RRF-40..86-PEG	51080a	SSE815..	11030a	TTM09..	50020a	VG-018M..	51630a
RRF-50..86-PEG	51080a	SSE8157..	11100a	TTM10..	50020a	VG-022-01	51630a
RRF-57..28-PEG	51040a	SSE8157..VG	11180a	TTM11..	50030a	VG-113SM-08G	51820a
RRF-57..43-PEG	51050a	SSE8157TAB..VG	11180a	TTM12..	50030a	VG-1568M..	52611a
RRF-60..86-PEG	51080a	SSE8810..	11080a	TTM21..	50040a	VG-213..	53565a
RRF-67..43-PEG	51050a	SSE881..VG	11170a	TTM22..	50040a	VG-213R-TOP..	53590a
RSHOE-S330	50600b	SSE881M..	11060a	TTM23..	50040a	VG-222JQ..	51810a
S800..	11030b	SSE881MO..	11060a	TTM31..	50040a	VG-223R..	53565a
S815..	11030b	SSE881MO..	11160a	TTM32..	50040a	VG-223R-TOP..	53590a
SCREW21M5-SS	30615a	SSE8810..	11080a	TTM33..	50040a	VG-245..	53575a
SF-CD1..	54540a	SSE881OTAB..	11070a	TTM37	50040a	VG-253..	53570a
SF-SPS..	54540a	SS881OTAB..	11070a	TTM39..	50060a	VG-254..	53570a
SHOE-15L105..	51150a	SSE881RTAB..	11070a	TTM40..	50060a	VG-3050..	54020a
SHOE-48..	52611a	SSE881TAB..VG	11170a	TTM41..	50060a	VG-3051..	54050a
SHOE-49L26	52592a	SSE8857M..	11110a	TTM42..	50060a	VG-3052..	54050a
SHOE-49L42	52593a	SSE8857M..VG	11160a	TTM48..	50060a	VG-3055..	54050a
SHOE-53L102..	51140a	SSE8857TAB..	11110a	TTM52..	50060a	VG-3070..	54060a
SHOE-84L244..	51170a	SSEL815..	11020a	TTM61..	50050a	VG-3080..	54060a
SHOE-84L68..	51160a	SSEL815..	11030a	TTM62..	50050a	VG-3087..	54060a
SHOE-85L244..	51170a	SSEL881MO..	11060a	TTM64..	50101a	VG-3110..	54070a
SHOE-88L244..	51170a	SSER814..VG	11150a	TTM66..	50101a	VG-3115..	54070a
SHOE-89L152..	51170a	SSER815..VG	11150a	TTM68..	50070a	VG-60..	53615a
SHOE-94..	52611a	SSER815TAB..VG	11150a	TTM71..	50070a	VG-619..	53610a
SK38..DMS	11330a	SSL812..	11030a	TTM78..	50070a	VG-620..	53615a
SK38..RMS	11330a	SSL881MO..	11060a	TTM82..	50070a	VG-632..	54560a
SMB-60..	53625a	SSSR815..	11030a	TTM84..	50101a	VG-633..	54550a
SP-10049..	53535a	TC-20..	53610a	TTM85..	50101a	VG-634..	54550a
SP-10944T15	53545a	TC-60..	53625a	TTM86..	50101a	VG-641T..	53590a
SP-11253T15	53545a	TCHD-R150-R150-S	54080a	TTM87..	50101a	VG-686A-1.25-3M	52611a
SP-7550..	53515a	TC-R150-S	54080a	TTM90..	50091a	VG-687-1.4-3M	52612a
SP-R36T..	53535a	TEE..	51140a	TTM91..	50091a	VG-687-3.3-3M	52612a
SPSL815..	11020a	TEE-3815-BM10	54080a	TTM92..	50091a	VG-687FLEX-1.4-3M	52610a
SPSL881MO..	11060a	TEE-4415-BM10	54080a	TTM93..	50091a	VG-687H-1.4-3M	52611a
		TEE-4815-BM10	54080a	TTM96..	50091a	VG-687H-3.3-3M	52611a

Legend

Codes ending with .. indicate a group of item descriptions all starting with the code listed. Example: 2122.. (all item descriptions starting with 2122).
 Codes with .. in the middle indicate a group of item descriptions starting and ending with the codes listed. Example 2251..RS (all item descriptions starting with 2251 and ending with RS). **Information about item descriptions, printed in blue, is only available on our website: www.SystemPlastSmartGuide.com**

Chains & sprockets	Wear strips	Side guide brackets & accessories	Levelers
Modular belts & sprockets	Chain & belt return systems	Frame & structure supports	Bearing Supports
Curves & tracks	Side guide solutions	Miscellaneous products	Related information

Item description	Page code	Item description	Page code	Item description	Page code	Item description	Page code
VG-687LDB-M8	52612a	VG-LSSM..	51520a	VG-S4P330C..	50580b		
VG-687NP-1.4M	52612a	VG-LSSMT..	51520c	VG-S4-S3020..	50550a		
VG-687SP	52611a	VG-LSSR..	51520a	VG-S640M..	50560a		
VG-688-1.4-3M	52614a	VG-LSST..	51520b	VG-S840M..	50560a		
VG-688-3.3-3M	52614a	VG-LSST..	51520a	VG-SC..	54630a		
VG-688FLEX-1.4-3M	52610a	VG-LSST..	51520c	VG-SCL..	54630a		
VG-688H-1.4-3M	52613a	VG-LSSWF..	51520a	VG-SD..	51660a		
VG-688H-3.3-3M	52613a	VG-LSSWF..	51520b	VG-SP1040M..	50560a		
VG-750-10	50550b	VG-MBG-50-NS-10	50570a	VG-SP330C..	50580b		
VG-A2520..	51740b	VG-NG110..	51720a	VG-SP640M..	50560a		
VG-A330M..	50580a	VG-NG125..	51720a	VG-SP840M..	50560a		
VG-A600A..	51740a	VG-NG47..	51720a	VG-SSF-HT-10	51520a		
VG-A840..	52650a	VG-NG49..	51720a	VG-SSMT..	51520c		
VG-ABG..	51730a	VG-NG50..	51720a	VG-SSNG..	51520c		
VG-AP330C..	50580b	VG-NG81..	51720a	VG-SSTS..	51520b		
VG-BP..	54030a	VG-NG91..	51720a	VG-T425M..	50550b		
VG-BPT..	54030b	VG-P1040M..	50560a	VG-TP..	54030a		
VG-BPV..	54030b	VG-P105..	50650a	VG-U3041..	50550a		
VG-BWS-125-10	50570a	VG-P10MRD..	51710a	VG-U3042..	50550a		
VG-DB83M-B-10	51710a	VG-P12MRD..	51710a	VG-U3043..	50550a		
VG-F203M..	50550b	VG-P14BC..	50650a	VG-U4045..	50550a		
VG-F205M..	50550b	VG-P14HD..	50650b	VG-J23..	50520a		
VG-F205M..	51120a	VG-P18BC..	50650a	VG-Z18M.	50520a		
VG-F206M..	51120a	VG-P18CC-100	50530a	VG-Z20M..	50520a		
VG-F253M..	50550b	VG-P18HD..	50650b	VG-Z20WM..	50520a		
VG-F303M..	50550b	VG-P2520..	51740b	VG-Z21..	50520a		
VG-F403..	50550a	VG-P316BC..	50650a	VT1701T..	50170a		
VG-F403M..	50550b	VG-P316HD..	50650b	VT1710CT..	50170a		
VG-F503M..	50550b	VG-P330C..	50580a	VT1713CT..	50180a		
VG-F603M..	50550b	VG-P330CW..	50610a	VT1873T..	50160a		
VG-F703M..	50550b	VG-P330M..	50560a	VT880B..	50130a		
VG-G1020M..	51660b	VG-P516BC..	50650b	VT880T..	50110a		
VG-GD..	51660a	VG-P640M..	50560a	VT882..	50140a		
VG-H7816M..	51690a	VG-P650M..	50560a	VT882B..	50150a		
VG-H8716M..	51700a	VG-P680M..	50560a	VTC880..	50120a		
VG-H9014M..	51680a	VG-P7GABC..	50650a	VTR880B..	50130a		
VG-J100-125T..	50530a	VG-P7GAHD..	50650b	VTR882B..	50150a		
VG-J100-188..	50530b	VG-P813..	51740a	W1700	11530a		
VG-J21M..	50520a	VG-P816..	51740a				
VG-J23M..	50520a	VG-P822..	51740a				
VG-JEL-078..	50530a	VG-P834..	51740a				
VG-JL19M..	50520a	VG-P840DBM..	51710a				
VG-JS100-125..	50530a	VG-P840M..	50560a				
VG-JS100-188..	50530b	VG-P8MRD..	51710a				
VG-JS150-125..	50530a	VG-PBG5..	51730a				
VG-JS150-18..	50530b	VG-PBG7..	51730a				
VG-JS200-125..	50530a	VG-PD..	51660b				
VG-JS200-188..	50530b	VG-PM10BC..	50650b				
VG-JS3-075-125..	50530a	VG-PM4BC..	50650a				
VG-JSL075-125..	50530a	VG-Q-75-40..	53595a				
VG-JSL075-188..	50530b	VG-QSC..	53595a				
VG-L20M..	50520a	VG-QT-01	53595a				
VG-LGSF..	51520a	VG-S1020M..	51660b				
VG-LGSR..	51520a	VG-S1040M..	50560a				
VG-LGST..	51520b	VG-S330M..	50580a				
VG-LSSF..	51520a	VG-S4-330M..	50580a				

Legend

Codes ending with .. indicate a group of item descriptions all starting with the code listed. Example: 2122.. (all item descriptions starting with 2122).
 Codes with .. in the middle indicate a group of item descriptions starting and ending with the codes listed. Example 2251..RS (all item descriptions starting with 2251 and ending with RS). **Information about item descriptions, printed in blue, is only available on our website: www.SystemPlastSmartGuide.com**

Chains & sprockets	Wear strips	Side guide brackets & accessories	Levelers
Modular belts & sprockets	Chain & belt return systems	Frame & structure supports	Bearing Supports
Curves & tracks	Side guide solutions	Miscellaneous products	Related information

1. DEFINITIONS:

In these Terms and Conditions of Sale, "Seller" means System Plast S.r.l.; "Buyer" means the person, firm, company or corporation by whom the order is given; "Goods" means the goods (including any Software and Documentation, as defined in Clause 9) described in Seller's Acknowledgement of Order form; "Services" means the services described in Seller's Acknowledgement of Order Form; "Contract" means the written agreement (including these Terms and Conditions) made between Buyer and Seller for the supply of the Goods and/or provision of Services; "Contract Price" means the price payable to Seller by Buyer for the Goods and/or Services and "Seller Affiliate" means any company which is for the time being directly or indirectly controlled by the ultimate parent company of Seller. For the purposes of this definition, a company is directly controlled by or is a subsidiary of another company or companies which holds 50% or more of the shares carrying the right to vote at a general meeting of the first mentioned company and a particular company is indirectly controlled by another company or companies if a series of companies can be specified, beginning with that company or those companies and ending with the particular company, so related that each company in the series is directly controlled by one or more of the companies earlier in the series.

2. THE CONTRACT:

2.1 All orders must be in writing and are accepted subject to these Terms and Conditions of Sale. No terms or conditions put forward by Buyer and no representations, warranties, guarantees or other statements not contained in Seller's quotation or Acknowledgement of Order nor otherwise expressly agreed in writing by Seller shall be binding on Seller.

2.2 The Contract shall become effective only upon the date of acceptance of Buyer's order on Seller's Acknowledgement of Order form or upon the date of fulfilment of all conditions precedent stipulated in the Contract, whichever is the later (the "Effective Date"). If the details of the Goods or Services described in Seller's quotation differ from those set out in the Acknowledgement of Order Form the latter shall apply.

2.3 No alteration or variation to the Contract shall apply unless agreed in writing by both parties. However, Seller reserves the right to effect minor modifications and/or improvements to the Goods before delivery provided that the performance of the Goods is not adversely affected and that neither the Contract Price nor the delivery date is affected.

3. VALIDITY OF QUOTATION AND PRICES:

3.1 Unless previously withdrawn, Seller's quotation is open for acceptance within the period stated therein or, when no period is so stated, within thirty days after its date.

3.2 Prices are firm for delivery within the period stated in Seller's quotation and are exclusive of (a) Value Added Tax and (b) any similar and other taxes, duties, levies or other like charges arising outside Italy in connection with the performance of the Contract.

3.3 Prices (a) are for Goods delivered EXW (Ex works) Seller's shipping point, exclusive of freight, insurance and handling and (b) unless otherwise stated in the Seller's quotation, are exclusive of packing. If the Goods are to be packed, packing materials are non-returnable.

4. PAYMENT:

Payment shall be made: (a) in full without set-off, counterclaim or withholding of any kind (save where and to the extent that this cannot by law be excluded); and (b) in the currency of Seller's quotation within thirty days of date of invoice unless otherwise specified by Seller's Finance Department. Goods will be invoiced at any time after their readiness for despatch has been notified to Buyer. Services will be invoiced monthly in arrears or, if earlier, upon completion. Without prejudice to Seller's other rights, Seller reserves the right to: (i) charge interest on any overdue sums at Unicredit Banca d'Impresa S.p.A. Brescia, Italy (or such higher rate stipulated by applicable law) during the period of delay; (ii) suspend performance of the Contract (including withholding shipment) in the event that Buyer fails or in Seller's reasonable opinion it appears that Buyer is likely to fail to make payment when due under the Contract or any other contract; and (iii) at any time require such reasonable security for payment as Seller may deem reasonable.

5. DELIVERY PERIOD:

5.1 Unless otherwise stated in Seller's quotation, all periods stated for delivery or completion run from the Effective Date and are to be treated as estimates only not involving any contractual obligations.

5.2 If Seller is delayed in or prevented from performing any of its obligations under the Contract due to the acts or omissions of Buyer or its agents (including but not limited to failure to provide specifications and/or fully dimensioned working drawings and/or such other information as Seller reasonably requires to proceed expeditiously with its obligations under the Contract), the delivery/completion period and the Contract Price shall both be adjusted accordingly.

5.3 If delivery is delayed due to any act or omission of Buyer, or if having been notified that the Goods are ready for despatch, Buyer fails to take delivery or provide adequate shipping instructions, Seller shall be entitled to place the Goods into a suitable store at Buyer's expense. Upon placing the Goods into the store, delivery shall be deemed to be complete, risk in the Goods shall pass to Buyer and Buyer shall pay Seller accordingly.

6. FORCE MAJEURE:

6.1 The Contract (other than Buyer's obligation to pay all sums due to Seller in accordance with the Contract) shall be suspended, without liability, in the event and to the extent that its performance is prevented or delayed due to any circumstance beyond the reasonable control of the party affected, including but not limited to: Act of God,

war, armed conflict or terrorist attack, riot, fire, explosion, accident, flood, sabotage; governmental decisions or actions (including but not limited to prohibition of exports or re-exports or the failure to grant or the revocation of applicable export licenses), or labour trouble, strike, lockout or injunction. Seller shall have no obligation to supply any hardware, software, services or technology unless and until it has received any necessary licences or authorisations or has qualified for general licences or licence exceptions under applicable import, export control and sanctions laws, regulations, orders and requirements, as they may be amended from time to time (including without limitation those of the United States, the European Union and the jurisdiction in which Seller is established or from which the items are supplied). If for any reason any such licenses, authorisations or approvals are denied or revoked, or if there is a change in any such applicable laws, regulations, orders or requirements that would prohibit Seller from fulfilling the Contract, or would in the reasonable judgement of Seller otherwise expose Seller and/or Seller Affiliate(s) to a risk of liability under applicable laws, regulations, orders or requirements, Seller shall be relieved without liability of all obligations under the Contract.

6.2 If either party is delayed or prevented from performance of its obligations by reason of this Clause for more than 180 consecutive calendar days, either party may terminate the then unperformed portion of the Contract by notice in writing given to the other party, without liability provided that Buyer shall be obliged to pay the reasonable cost and expense of any work in progress and to pay for all Goods delivered and Services performed as at the date of termination. Seller may deliver by instalments and if so each delivery shall constitute a separate contract and failure by Seller to deliver any one or more of the instalments in accordance with their terms shall not entitle Buyer to terminate the whole Contract or treat it as repudiated.

7. INSPECTION, TESTING, AND CALIBRATION:

7.1 Goods will be inspected by Seller or manufacturer and, where practicable, submitted to Seller's or manufacturer's standard tests before despatch. Any additional tests or inspection (including inspection by Buyer or its representative, or tests in the presence of Buyer or its representative and/or calibration) or the supply of test certificates and/or detailed test results shall be subject to Seller's prior written agreement and Seller reserves the right to charge therefore; if Buyer or its representative fails to attend such tests, inspection and/or calibration after seven days' notice that the Goods are ready therefore, the tests, inspection and/or calibration will proceed and shall be deemed to have been made in the presence of Buyer or its representative and the Seller's statement that the Goods have passed such testing and/or inspection and/or have been calibrated shall be conclusive.

7.2 Claims for shortfalls in quantity or for incorrect delivery shall be void if made more than 14 days after delivery.

8. DELIVERY, RISK & TITLE:

8.1 Unless otherwise expressly stated in the Contract, the Goods will be delivered Carriage Paid To (CPT) the destination named in the Contract; freight, packing and handling will be charged at Seller's standard rates. Risk of loss of or damage to the Goods shall pass to Buyer upon delivery as aforesaid and Buyer shall be responsible for insurance of the Goods after risk has so passed. Alternatively, if it is expressly stated in the Contract that Seller is responsible for the insurance of the Goods after their delivery to the carrier, such insurance will be charged at Seller's standard rates. "Ex-works"; "FCA"; "CPT" and any other delivery terms used in the Contract shall be defined in accordance with the latest version of Incoterms.

8.2 Subject to Clause 8.1, title to the Goods shall pass to Buyer upon delivery.

9. DOCUMENTATION AND SOFTWARE:

9.1 Title to and ownership of the copyrights in software and/or firmware incorporated into or provided for use with the Goods ("Software") and documentation supplied with the Goods ("Documentation") shall remain with the relevant Seller Affiliate (or such other party as may have supplied the Software and/or Documentation to Seller) and is not transferred hereby to Buyer.

9.2 Except as otherwise provided herein, Buyer is hereby granted a non-exclusive, royalty-free licence to use the Software and Documentation in conjunction with the Goods, provided that and for so long as the Software and Documentation are not copied (unless expressly authorised by applicable law) and Buyer holds the Software and Documentation in strict confidence and does not disclose them to others, or permit others to have access to them (other than Seller's standard operating and maintenance manuals). Buyer may transfer the foregoing licence to another party which purchases, rents or leases the Goods, provided the other party accepts and agrees in writing to be bound by the conditions of this Clause 9.

9.3 Notwithstanding Sub-clause 9.2, Buyer's use of certain Software, (as specified by Seller and including but not limited to control system and AMS Software) shall be governed exclusively by the applicable Seller Affiliate or third party licence agreement.

9.4 Seller and Seller Affiliates shall retain ownership of all inventions, designs and processes made or evolved by them and save as set out in this Clause 9 no rights in intellectual property are hereby granted.

10. DEFECTS AFTER DELIVERY:

10.1 Seller warrants (i) subject to the other provisions of the Contract, good title to and the unencumbered use of the Goods; (ii) that Goods manufactured by Seller and/or Seller's Affiliates shall conform with Seller's specifications therefore and be free of defects in materials and workmanship and (iii) that Services provided by Seller or Seller Affiliates will be performed with all reasonable skill, care and due diligence and in accordance with good engineering practice. Seller will make good, by repair or at Seller's option by the supply of a replacement part or parts, any defects which, under proper use, care and maintenance, appear in Goods of Seller Affiliates' manufacture and which are reported to Seller within 12 calendar months from putting such Goods

into operation or 18 calendar months after their delivery, whichever period expires the sooner, (90 days after delivery in the case of Consumables and spare parts) (the "Warranty Period") and which arise solely from faulty materials or workmanship: provided always that defective items are returned to Seller at Buyer's cost carriage and insurance prepaid within the Warranty Period. ("Consumables" shall include glass electrodes, membranes, liquid junctions, electrolyte and O-rings). Replaced items shall become the property of the Seller. Repaired or replacement items will be delivered by Seller at Seller's cost to Buyer's mainland site in Italy or, if Buyer is located outside Italy, FCA in Italy. Seller will correct defects in Services provided by Seller or Seller Affiliates and reported to Seller within ninety days after completion of such Services. Goods or Services repaired, replaced or corrected in accordance with this Clause 10.1 shall be subject to the foregoing warranty for the unexpired portion of the Warranty Period or for ninety days from the date of their return to Buyer (or completion of correction in the case of Services), whichever expires the later.

10.2 Goods or Services sourced by Seller from a third party (not being a Seller Affiliate) for resale to Buyer shall carry only the warranty extended by the original manufacturer.

10.3 Notwithstanding Clauses 10.1 and 10.2, Seller shall not be liable for any defects caused by: fair wear and tear; materials or workmanship made, furnished or specified by Buyer; non-compliance with Seller's storage, installation, operation or environmental requirements; lack of proper maintenance; any modification or repair not previously authorised by Seller in writing; nor the use of non-authorized software or spare or replacement parts. Seller's costs incurred in investigating and rectifying such defects shall be paid by Buyer upon demand. Buyer shall at all times remain solely responsible for the adequacy and accuracy of all information supplied by it.

10.4 Subject to Clause 12, the foregoing constitutes Seller's sole warranty and Buyer's exclusive remedy for breach thereof. No representations, warranties or conditions of any kind, express or implied, shall apply as to satisfactory quality, merchantability, fitness for any particular purpose or any other matter with respect to any of the Goods or Services.

11. PATENT, ETC. INFRINGEMENT:

11.1 Subject to the limitations set forth in Clause 12, Seller shall indemnify Buyer in the event of any claim for infringement of Letters Patent, Registered Design, Design Right, Trade Mark or Copyright ("Intellectual Property Rights") existing at the date of formation of the Contract arising from the use or sale of the Goods, against all reasonable costs and damages awarded against Buyer in any action for such infringement, or for which Buyer may become liable in any such action, provided always that Seller shall not be liable to so indemnify Buyer in the event that:

(i) such infringement arises as a result of Seller having followed a design or instruction furnished or given by Buyer, or the Goods having been used in a manner or for a purpose or in a country not specified by or disclosed to Seller prior to the date of the Contract or in association or combination with any other equipment or software, or (ii) Seller has at its expense procured for Buyer the right to continue to use the Goods or has modified or replaced the Goods so that the Goods no longer infringe, or (iii) Buyer has failed to give Seller the earliest possible notice in writing of any claim made or to be made or of any action threatened or brought against Buyer and/or Buyer has failed to permit Seller, at Seller's expense, to conduct and control any litigation that may ensue and all negotiations for a settlement of the claim, or (iv) Buyer has made without Seller's prior written consent any admission which is or may be prejudicial to Seller in respect of any such claim or action, or (v) the Goods have been modified without Seller's prior written authorisation.

11.2 Buyer warrants that any design or instructions furnished or given by it shall not cause Seller to infringe any Intellectual Property Rights in the performance of Seller's obligations under the Contract and shall indemnify Seller against all reasonable costs and damages which Seller may incur as a result of any breach of such warranty.

12. LIMITATION OF LIABILITY:

Except for death or personal injury caused by Seller and for Seller's willful misconduct or gross negligence: (i) Seller's and Seller Affiliates' total liability for any and all damages, claims or causes of action howsoever arising (including, without limitation, damage, claims or causes of action by virtue of tort, by breach of contract or statutory duty, negligence, strict liability or infringement of Intellectual Property Rights) shall not exceed the Contract Price; and (ii) Seller and Seller Affiliates shall not be liable to Buyer in any circumstances for any loss of profits, loss of contracts, loss of use, loss of data or consequential or indirect loss nor, save as set out in Clause 11 and in the preceding provisions of this Clause, for any loss or damage of any kind whatsoever, howsoever arising, claimed against or suffered by Buyer.

13. STATUTORY AND OTHER REGULATIONS:

13.1 If Seller's obligations under the Contract shall be increased or reduced by reason of the making or amendment after the date of Seller's quotation of any law or any order, regulation or by-law having the force of law that shall affect the performance of Seller's obligations under the Contract, the Contract Price and delivery period shall be adjusted accordingly and/or performance of the Contract suspended or terminated, as appropriate.

13.2 Except to the extent otherwise required by applicable law, Seller shall have no responsibility for the collection, treatment, recovery or disposal of (i) the Goods or any part thereof when they are deemed by law to be 'waste' or (ii) any items for which the Goods or any part thereof are replacements. If Seller is required by applicable law, including waste electrical and electronic equipment legislation, in particular European Directives 2002/96/EC (WEEE) and 2003/108/EC as implemented by Legislative Decree dated July 25, 2005 no. 151, to dispose of 'waste' Goods or any part thereof, Buyer shall, unless prohibited by applicable law, pay Seller, in addition to the Contract Price, either (i) Seller's standard charge for disposing of such Goods or (ii) if Seller does not have such a standard charge, Seller's costs (including all handling, transportation and disposal costs and a reasonable mark-up for overhead) incurred in disposing of such Goods.

13.3 Buyer's personnel shall, whilst on Seller's premises, comply with Seller's applicable site regulations and Seller's reasonable instructions, including but not limited to those relating to safety, security and electrostatic discharge.

14. COMPLIANCE WITH LAWS

Buyer agrees that all applicable import, export control and sanctions laws, regulations, orders and requirements, as they may be amended from time to time, including without limitation those of the United States, the European Union and the jurisdictions in which Seller and Buyer are established or from which items may be supplied, and the requirements of any licenses, authorisations, general licences or licence exceptions relating thereto will apply to its receipt and use of hardware, software, services and technology. In no event shall Buyer use, transfer, release, export or re-export any such hardware, software or technology in violation of such applicable laws, regulations, orders or requirements or the requirements of any licences, authorisations or licence exceptions relating thereto. Buyer agrees furthermore that it shall not engage in any activity that would expose the Seller or any of its affiliates to a risk of penalties under laws and regulations of any relevant jurisdiction prohibiting improper payments, including but not limited to bribes, to officials of any government or of any agency, instrumentality or political subdivision thereof, to political parties or political party officials or candidates for public office, or to any employee of any customer or supplier. Buyer agrees to comply with all appropriate legal, ethical and compliance requirements.

15. DEFAULT, INSOLVENCY AND CANCELLATION:

Seller shall be entitled, without prejudice to any other rights it may have, to cancel the Contract forthwith, wholly or partly, by notice in writing to Buyer, if (a) Buyer is in default of any of its obligations under the Contract and fails, within 30 (thirty) days of the date of Seller's notification in writing of the existence of the default, either to rectify such default if it is reasonably capable of being rectified within such period or, if the default is not reasonably capable of being rectified within such period, to take action to remedy the default or (b) on the occurrence of an Insolvency Event in relation to Buyer. "Insolvency Event" in relation to Buyer means any of the following: (i) a meeting of creditors of Buyer being held or an arrangement or composition with or for the benefit of its creditors being proposed by or in relation to Buyer; (ii) a chargeholder, receiver, administrative receiver or similar person taking possession of or being appointed over or any distress, execution or other process being levied or enforced (and not being discharged within seven days) on the whole or a material part of the assets of Buyer; (iii) Buyer ceasing to carry on business or being unable to pay its debts; (iv) Buyer or its directors or the holder of a qualifying floating charge giving notice of their intention to appoint, or making an application to the court for the appointment of, an administrator; (v) a petition being presented (and not being discharged within 28 days) or a resolution being passed or an order being made for the administration or the winding-up, bankruptcy or dissolution of Buyer; or (vi) the happening in relation to Buyer of an event analogous to any of the above in any jurisdiction in which it is incorporated or resident or in which it carries on business or has assets. Seller shall be entitled to recover from Buyer or Buyer's representative all costs and damages incurred by Seller as a result of such cancellation, including a reasonable allowance for overheads and profit (including but not limited to loss of prospective profits and overheads).

16. SUPPLEMENTARY TERMS AND CONDITIONS:

If the Goods comprise or include a control system, Seller's Supplementary Terms and Conditions Applicable to the Supply of Control Systems and Related Services shall apply to the control system and related services only. Such Supplementary Terms and Conditions shall take precedence over these Standard Terms and Conditions of Sale; copies are available from Seller upon request

17. MISCELLANEOUS:

17.1 No waiver by either party with respect to any breach or default or of any right or remedy and no course of dealing, shall be deemed to constitute a continuing waiver of any other breach or default or of any other right or remedy, unless such waiver be expressed in writing and signed by the party to be bound.

17.2 If any clause, sub-clause or other provision of the Contract is invalid under any statute or rule of law, such provision, to that extent only, shall be deemed to be omitted without affecting the validity of the remainder of the Contract.

17.3 Buyer shall not be entitled to assign its rights or obligations hereunder without the prior written consent of Seller.

17.4 Seller enters into the Contract as principal. Buyer agrees to look only to Seller for due performance of the Contract.

17.5 GOODS AND SERVICES PROVIDED HEREUNDER ARE NOT SOLD OR INTENDED FOR USE IN ANY NUCLEAR OR NUCLEAR RELATED APPLICATIONS. Buyer (i) accepts Goods and Services in accordance with the foregoing restriction, (ii) agrees to communicate such restriction in writing to any and all subsequent purchasers or users and (iii) agrees to defend, indemnify and hold harmless Seller and Seller Affiliates from any and all claims, losses, liabilities, suits, judgements and damages, including incidental and consequential damages, arising from use of Goods and Services in any nuclear or nuclear related applications, whether the cause of action be based in tort, contract or otherwise, including allegations that the Seller's liability is based on negligence or strict liability.

17.6 The Contract shall in all respects be construed in accordance with the laws of Italy excluding, however, any effect on such laws of the 1980 Vienna Convention on Contracts for the International Sale of Goods, and to the fullest extent permitted by Law, shall be without regard to any conflict of laws or rules which might apply by the laws of any other jurisdiction. All disputes arising out of the Contract shall be subject to the exclusive jurisdiction of the courts in Milan, Italy.

17.7 The headings to the Clauses and paragraphs of the Contract are for guidance only and shall not affect the interpretation thereof.

17.8 All notices and claims in connection with the Contract must be in writing.

System Plast S.r.l.
Via G. Guareschi, 2
24060 Telgate (Bergamo)
Italy